



JB INDUSTRIES

PRODUCT
55
CATALOG





ESTABLISHED

IN 1967

Everyone was ready for a return in 2022 to normal operations and activity. However, the year brought more challenges than anyone expected. We expect that 2023 will bring us a reduction in supply chain disruptions and volatile inflationary pressures.

In 2022, JB, as a USA manufacturer in Aurora, Illinois, continued to operate relatively normally. Despite stocking large quantities of raw material there were so many instances where an “o” ring or other small parts prevented JB from building and shipping as efficiently as we expect.

We are so appreciative of our domestic suppliers keeping us running and are fortunate and grateful for all the hard work and dedication of the JB team. So many worked six days a week to support our customers. While always looking for cost efficiencies and helping minimize price volatility, JB will never sacrifice the product quality and delivery that are synonymous with the JB name.

A quick fun fact: 85% of JB products sold are Made in America. The remaining are engineered and designed in America.

The JB team is especially proud of the new products in this year’s catalog. These JB designed and manufactured products not only were recognized by the industry with awards, but also provide time-saving tools for our customers. Our newest products include:

- PLATINUM BEAST 12 CFM pump and the industries best AC/Battery Powered Vacuum Pump PLATINUM FLEX
- F6-BOOST Recovery Machine with industry leading speeds
- ATLAS DS-5000 Propane Scale
- ATLAS DS-250 Digital Scale
- CLIMATE CLASS Wireless Temperature Clamps and Psychrometers
- ACCELERATOR Rapid Evacuation Kit

We are also excited about our longer-term product road map that will include new wireless products, a revamped pump line-up, and other innovative products to make users of JB tools more efficient to complete their jobs faster.

JB continues to add videos and increase social media presence. Please connect with us to see all the great content.

As we enter 2023, we are always thankful for the continued business and partnerships. JB’s plan, like it has been for the last 55 years, is simply to continue to manufacture, design, and offer the best products in the industry.

We thank our customers for the continued support and look forward to a great 2023 and beyond together!

Jeff Cherif
President

FOR OVER 55 YEARS JB INDUSTRIES HAS DESIGNED, ENGINEERED, AND MANUFACTURED:

ACCESS VALVES

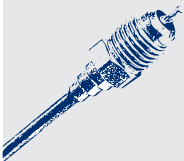

MANIFOLDS

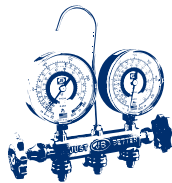

VACUUM PUMPS



HOSES



BRASS FITTINGS

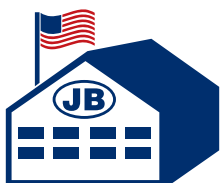

JB MAKES
> 10 MILLION
BRASS CAPS

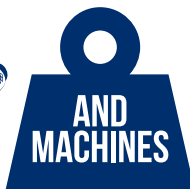

MILLIONS
OF LBS OF BRASS
EACH YEAR

BUILT ON

Tradition

Innovation

Quality

People

Climate Class

Wireless Temperature Clamps **4**
 Wireless Psychrometers **5**

Digital Manifolds

REVOLVER® DM4-RW Digital Wireless . . . **6**
 ZEPPELIN® DM4-ZW Digital Wireless . . . **7**

Vacuum Pumps/Accessories

PLATINUM® BEAST Pump **8**
 PLATINUM® FLEX Pumps **9**
 PLATINUM® Pumps **10**
 ELIMINATOR® Pumps **11**
 ACCELERATOR VL-200 **12**
 VELOCITY VL-100 **12**
 Y-FORCE **13**
 The TANK **13**
 BLACK GOLD **13**

Refrigerant Recovery

F6-BOOST BLDC Ignition-Proof
 Refrigerant Recovery Machine **14**
 F6-DP™ Refrigerant Recovery Machine . . . **15**

Refrigerant Scales

ATLAS® DS-5000 Propane **16**
 ATLAS® DS-250 Wireless **17**
 ATLAS® DS-20000 Digital **17**

Digital Vacuum Gauges

DV-22N/DV-24N **18**
 DVR-22 **18**
 SUPERNOVA® DV-41 **19**
 SH-35N Wireless **19**

Leak Detection

PROWLER® LD-5000 **21**
 LDC-4000 **21**
 QUEST® LD-3000 **21**

Manifolds

PATRIOT™ 2-Valve Brass **22**
 REVOLVER® 4-Valve Ball **23**
 ZEPPELIN® 2-Valve Aluminum **24**
 ZEPPELIN® 4-Valve Aluminum **25**
 M2 Standard **26**
 M2 Heat Pump **27**
 CO2 **27**
 Metric **27**

Gauges

LED **28**
 A2L/Hydrocarbon Gas **28**
 Gauge Boots and Replacement Lenses . . **28**
 Gas Pressure Test Kits **28**
 Gas Test Gauges **28**
 Gauge Options **29**
 Metric **29**

Refrigerant Hoses

CNTL90 Series Pressure Control **30**
 CLRF Series Flexible Hydrocarbon **30**
 KOBRA® CLSX Series **31**
 KOBRA® CLSX Series Repair **31**
 KOBRA® CLS Series **32**
 KOBRA® CLS Series Repair **32**
 KOBRA® CLE Series **33**
 KOBRA® CLB Series **33**
 KOBRA® CLV, CLV6, CLP Series **34**
 Heavy-Duty Black Charging Series **34**
 Standard Series **34**
 Hose Replacement Parts **35**
 Mini Ball-Valves **35**
 Flexible Metal Hose **35**
 Secure Seal Adapters **35**

Mini-Split Tool Kits

MSKIT1, MSKIT2 and MSKIT3 **36**

SHIELD® Locking Caps 38

CoreMax® 39

Access Valves

Access Valve Overview **40**
 Copper Tube Extension **41**
 Copper Braze Tapper **41**
 Copper 90° Elbow **41**
 Copper Braze Tee **42**
 Copper Access Union **42**
 Service Kit **42**
 Swivel Flare **43**
 Coupler with Depressor **43**
 Bulkhead Mounting **43**
 Crosses **43**
 MPT Connections **44**
 Valve Core Removal Tools with
 Slide Valve Side Port **45**
 Valve Cores and Removal Tools **46**
 Seal Caps **47**
 O-ring Seal Line Piercing **47**
 Backseating Control Valve **47**
 Quick Couplers **48**
 Swivel Cylinder Valve **48**
 Core Depressor **48**
 Liquid Charging Adapters **48**
 O-Rings/Gaskets/Tool **49**

Brass Fittings

American-made Brass **49**
 Flared Tube Fittings **53**
 Brass Pipe Fittings **54**
 One-way Check Valve **57**

Ball Valves

Shutoff **58**
 Needle **58**
 E-Line Retrofit Caps **58**
 Refrigerant Ball Valves **59**
 E-Line Actuators **59**

Just Better Tools

Tube Cutters **60**
 Pipe Shears **61**
 Solenoid Magnet **61**
 Aluminum Pipe Wrench **62**
 Pliers **62**
 Slim Profile Adjustable Wrench **62**
 Service Wrenches **63**
 Torque Wrench Kit **63**
 Imperial Spanner Heads **63**
 Tube Benders **63**
 Spring Tube Benders **64**
 Flaring Tools **64**
 Tube Expander Kit **65**
 Hex Key Adapter **65**
 Steel Strap **65**
 Oil Transfer Pump **65**
 Swage Tools **66**
 Braze-Rite Adapter **67**
 Pinch-Off Tool **67**
 Deburring Tools **67**
 Fin Straighteners **67**
 O-ring/Gasket Removal Tool **67**

Capillary Tubing 68

Automotive 70

LA-CO Products 71

Warranty and Returns 72

Repair Parts 74

Index 79

Sales Contacts 83

We Make Them Like They Used To

American-Made Strength, Quality and Ingenuity

The heartland of America is where JB Industries was founded in 1967, and it's where we're still manufacturing today. Raw materials, milled in the USA, come into our manufacturing plant and then we produce rugged, long-lasting HVACR tools delivered to wholesalers nationwide, without worry of international supply-chain issues.

Hands-down our pumps outlast any vacuum pump you can buy. And we have options that cover everyone's needs. From 1 CFM all the way up to 12 CFM there's an option for all your job-size needs. Not only does JB offer a variety of pump sizes, we also have options for:

- Spark-Free
- A2L/A3
- Dual Power (Battery and AC)
- Dual Voltage

Whatever the vacuum pump need, JB fills it with fast, efficient, reliable, high-quality vacuum pumps.

And pumps aren't the only thing we're good at. Check out our new wireless CLIMATE CLASS system, the F6-BOOST Recovery Machine that is 20X faster than the competition, our award-winning brass accessories, proven hoses with JB forged brass fittings, and a whole host of other HVACR products.

Check out our website frequently to see What's New Throughout 2023!

CLIMATE CLASS

NEW

Wireless Temperature Clamps

- Measures pipe temperatures in HVACR; Robust Thermistor sensor for accurate temperature measurements
- Bright OLED screen displays information (does not require an IOS or Android app); includes battery life indicator
- 2 button interface and intuitive menu offers easy setting adjustments
- Over-molded parts for increased grip and durability
- 1 year warranty

Specifications

Sensor Type	Thermistor
Temperature Units	Fahrenheit, Celsius
Temperature Range	-40 to 302 °F
Accuracy	±2.3 °F (-4 to 185 °F)
Resolution	0.1 °F
Pipe Diameter Range	1/4" to 2"; Large jaws
Bluetooth® Range	Up to 350ft (106.6m) – Dependent on environment
Power Supply	Two AA batteries (included)
Battery Life	Approximately 120 hours; indicator light
Operating Temperature	+32°F to 122°F (0°C to +50°C)
Storage Temperature	+14°F to 140°F (-10°C to +60°C)
Storage Humidity	85% RH @113°F (45°C), non-condensing
Display	OLED
Unit Weight	6.5 oz
Compatibility	iOS Version: 10.0+, Android Version: 6.0+
IP Rating	IP-54



PART NO.	DESCRIPTION
WC-1	Individual Wireless Temperature Clamp (1)
WC-2	Set of Wireless Temperature Clamps in Case (2)

CLIMATE CLASS

Wireless Psychrometers

NEW

- Measures temperature and humidity (Wet Bulb, Dry Bulb, Relative Humidity and Dew Point)
- Permanent swivel cap twists to protect the sensor when not in use; Flexible wand for pin-pointing specific areas
- Bright OLED screen displays information (without requiring an iOS or Android app); battery life indicator
- 2 button interface and intuitive menu offers easy setting adjustments
- Over-molded parts for increased grip and durability; Rear-mounted magnet for easy and secure positioning
- 1 year warranty

Specifications

Sensor Type	Digital Humidity and Temperature Sensor
Temperature Range	-40 to +275°F (-40 to +125°C)
Temperature Units	Fahrenheit, Celsius
Humidity Range	0% to 100% Relative Humidity
Accuracy Humidity	± 2% RH
Temperature Accuracy	± .36°F (± .2°C)
Bluetooth Range	Up to 350ft (106.6m) - Dependent on environment
Power Supply	2 x AA batteries (included)
Battery Life	Approximately 120 hours; indicator light
Operating Temperature	+32°F to 122°F (0°C to +50°C)
Storage Temperature	+14°F to 140°F (-10°C to +60°C)
Storage Humidity	85% RH @113°F (45°C), non-condensing
Display	OLED
Unit Weight	6.2 oz
Compatibility	iOS Version: 10.0+, Android Version: 6.0+



PART NO.	DESCRIPTION
WH-1	Individual Psychrometer/Hygrometer (1)
WH-2	Set of Psychrometers/Hygrometers in Case (2)

JB GO Combined Tool App



The **JB GO** app is designed to make working on-site with JB wireless and digital tools accurate, fast and efficient. JB wireless and digital tools have been designed to help technicians and contractors log data and get accurate readouts while on-site. The **JB GO** app works with the following tools:

- CLIMATE CLASS Wireless Temperature Tools
- DM4-ZW ZEPPELIN® Wireless Digital Manifold
- DM4-RW REVOLVER® Wireless Digital Manifold
- ATLAS® DS-250 Wireless Refrigerant Scale
- SH-35N Wireless Gauge for Superheat/Subcooling



Look for more **CLIMATE CLASS** products coming soon in 2023!

WIRELESS CONNECTIVITY & EASY-TO-USE

Both WC-2 and WH-2 come with a durable hard-side case.



- Digital Manifolds
- Vacuum Pumps
- Recovery
- Scales
- Digital Gauges
- Leak Detection
- Manifolds/Gauges
- Hoses
- Mini-Split Tool Kits
- SHIELD
- CoreMax
- Access Valves
- Brass Fittings
- Ball Valves
- Just Better Tools
- Capillary Tubing
- Automotive/LA-CO
- Warranty/Repair
- Index/Contacts

Digital Manifolds

JB INDUSTRIES
NEW

DM4-RW

REVOLVER® Wireless Digital Manifold

- Wirelessly connects to smart devices through the **JB GO** app
- Simple, easy-to-navigate menu with transreflective display for easy reading in direct sunlight
- 60+ Refrigerants; update with new refrigerants through app
- Measures high side and low side pressure (ps, kPa, and bar) and temperature (°F and °C)
- Calculates superheat, subcooling, vapor and liquid saturation
- Laser welded stainless steel transducers
- Universal K-Type clamp thermocouples
- Protective boot and water-resistant design
- American-made forged brass REVOLVER® 4-valve liquid metering, ball valve style manifold 
- Quarter-turn full open/close handle and 3/8" bore for faster evacuation
- 60" CCLE4-60 KOBRA® hose set included (4 pack)
- Protective carrying case allows storage with connected hoses
- Convenient strap with hanging hook
- Operates with three AA batteries (included)
- 1 year warranty

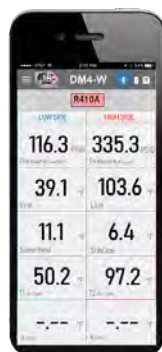
**WIRELESS
CONNECTIVITY &
EASY-TO-USE**



Leave hoses attached in convenient hanging case

PART NO.	DESCRIPTION
DM4-RW	REVOLVER® Digital Manifold (including parts listed below)
REPLACEMENT PART NO.	DESCRIPTION
DM4-CS	Digital manifold protective carrying case
DM4-TC	Temperature clamp (1)
DM4-BRK	Brackets for clamps and strap
DM4-STRP	Strap with hook
DM4-BT	Protective boot
CCLE4-60	60" Gasket seal KOBRA® hose set (4)

NEW

DM4-ZW

ZEPPELIN® Wireless Digital Manifold

- Wirelessly connects to smart devices through the **JB GO** app
- Simple, easy-to-navigate menu with transreflective display for easy reading in direct sunlight
- 60+ Refrigerants; update with new refrigerants through app
- Measures high side and low side pressure (ps, kPa and bar) and temperature (°F and °C)
- Calculates superheat, subcooling, vapor and liquid saturation
- Laser welded stainless steel transducers
- Universal K-Type clamp thermocouples
- Protective boot and water-resistant design
- American-made heavy-duty forged aluminum ZEPPELIN® 4-valve piston style manifold 
- 3/8" bore for faster evacuation
- 60" CCLE4-60 KOBRA® hose set included (4 pack)
- Soft grip rubber handwheels reduce turning to open/close
- Protective carrying case allows storage with connected hoses
- Convenient strap with hanging hook
- Operates with three AA batteries (included)
- 1 year warranty

**WIRELESS
CONNECTIVITY &
EASY-TO-USE**

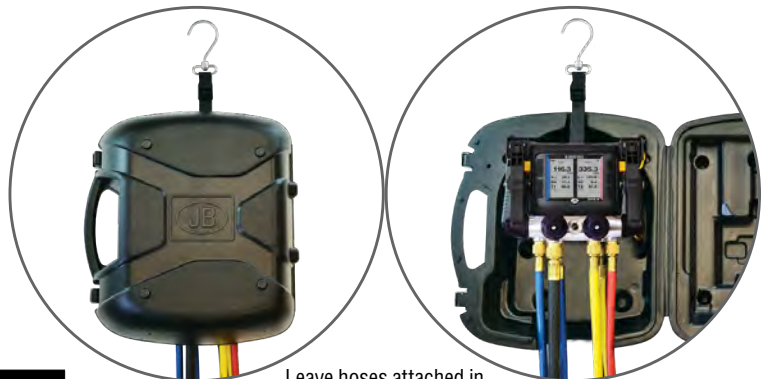

Leave hoses attached in convenient hanging case



PART NO.	DESCRIPTION
DM4-ZW	ZEPPELIN® Digital Manifold (including parts listed below)
REPLACEMENT PART NO.	DESCRIPTION
DM4-CS	Digital manifold protective carrying case
DM4-TC	Temperature clamp (1)
DM4-BRK	Brackets for clamps and strap
DM4-STRP	Strap with hook
DM4-BT	Protective boot
CCLE4-60	60" Gasket seal KOBRA® hose set (4)

PLATINUM BEAST

NEW

**TEAR THROUGH YOUR WORKLOAD.
JUST FASTER. JUST BETTER.**

12 CFM Vacuum Pump



PLATINUM [®] BEAST 12 CFM VACUUM PUMP	
	DV-340N
CFM	12 CFM (340 l/m)
MOTOR	1 HP, DC
VOLTAGE	115v/230v
INTAKE PORT	1/2" x 1/4" x 3/8"
OIL CAPACITY	32 oz
WEIGHT	34 lb

- 1 HP DC motor with broad operating voltage range
- 2-stage direct drive
- Dual-voltage switch 115v/230v
- 15 micron vacuum rating
- Gas ballast and blank-off isolation valve
- Internal check valve prevents oil back-flow during power failure
- Easy access 1/4", 3/8" or 1/2" intake tee
- Field Repairable; see page 75 for repair parts
- 2 year OTC warranty
- Made in the USA

Vacuum Pumps Change Your Pump Oil

Deep vacuum cannot be achieved with contaminated oil which can damage the pump and shorten pump life. JB recommends pump oil be changed after every evacuation for maximum performance and pump efficiency.

Use a Micron Gauge

The best test to check for oil contamination is through a micron gauge. In a leak-free system, if the micron gauge is not reading a deep vacuum, the oil is contaminated and should be changed. During the testing process is the only time it is recommended to have a micron gauge attached directly to pump.

Choosing Proper CFM

CFM² = Maximum Tonnage Rating

Take the CFM rating and multiply it by that number to find the maximum number of tons a pump is rated for:

3 CFM pump (3x3) is rated for 9 tons
7 CFM pump (7x7) is rated for 49 tons

Depending on the system line size, it is better to use two or more small, easily maneuverable pumps at different locations to overcome pressure drop issues and evacuate faster than a single, large pump. Pumps in the 1.5 to 10 CFM class are adequate to handle 99% of the work. JB pumps are built to last and are the best and longest-lasting pumps in the industry.



PLATINUM FLEX

NEW

AC/Battery Powered Vacuum Pump EXTRA FREEDOM. EXTRA POWER. EXTRA CAPACITY.

Work better with the Dealer Design Award-winning PLATINUM® FLEX battery or AC-powered vacuum pump. American-made top-of-the-line for both quality and durability—Pump of Choice for HVACR technicians.

- Powered by JB's 9.0 Ah/18v lithium-ion battery or auto-switching dual voltage AC Adapter
- 1/2 HP DC brushless motor
- Available in 3 CFM or 5 CFM
- Low battery warning light with audible alert
- Easy access 1/4", 3/8" or 1/2" intake tee
- 15 micron vacuum rating
- Gas ballast and blank-off isolation valve
- Metal construction with finned aluminum heavy-duty housing, brass fittings and stainless steel valving
- Ergonomic 1/2" NPT exhaust handle with lift ring
- Large, easy-to-read oil level sight glass with easy access oil fill located on cover
- O-ring sealed oil drain valve to prevent leaks and tethered safety cap to prevent oil spills
- Internal check valve prevents oil back-flow during power failure
- 22oz. oil capacity
- Field repairable
- 1 year OTC warranty; 2 year on vacuum pump
- Made in the USA 



DV-142-FLEX



DV-BP-BAT



DV-BP-CHRG



DV-BP-AC

Accessories

Accessories shown right are available in pump kits or sold separately.

PLATINUM® FLEX BATTERY POWERED VACUUM PUMPS						
	DV-85-FLEX	DV-85-FLEX-AC	DV-85-FLEX-BAT	DV-142-FLEX	DV-142-FLEX-AC	DV-142-FLEX-BAT
CFM	3 CFM (85 l/m)	3 CFM (85 l/m)	3 CFM (85 l/m)	5 CFM (142 l/m)	5 CFM (142 l/m)	5 CFM (142 l/m)
MOTOR	1/2 HP, 1725 RPM	1/2 HP, 1725 RPM	1/2 HP, 1725 RPM	1/2 HP, 1725 RPM	1/2 HP, 1725 RPM	1/2 HP, 1725 RPM
VOLTAGE	Battery: 9.0 Ah/18v Adapter: 115v/60Hz 230v/50Hz	Battery: 9.0 Ah/18v Adapter: 115v/60Hz 230v/50Hz	Battery: 9.0 Ah/18v Adapter: 115v/60Hz 230v/50Hz	Battery: 9.0 Ah/18v Adapter: 115v/60Hz 230v/50Hz	Battery: 9.0 Ah/18v Adapter: 115v/60Hz 230v/50Hz	Battery: 9.0 Ah/18v Adapter: 115v/60Hz 230v/50Hz
INTAKE PORT	1/2" x 1/4" x 3/8"	1/2" x 1/4" x 3/8"	1/2" x 1/4" x 3/8"	1/2" x 1/4" x 3/8"	1/2" x 1/4" x 3/8"	1/2" x 1/4" x 3/8"
OIL CAPACITY	26oz (769cc)	26oz (769cc)	26oz (769cc)	21oz (621cc)	21oz (621cc)	21oz (621cc)
AC ADAPTER: DV-BP-AC	Included	Included	Not Included	Included	Included	Not Included
BATTERY: DV-BP-BAT CHARGER: DV-BP-CHRG	Included	Not Included	Included	Included	Not Included	Included
BATTERY RUN TIME	Approximately 90 minutes	Approximately 90 minutes	Approximately 90 minutes	Approximately 60 minutes	Approximately 60 minutes	Approximately 60 minutes

Cimate
Class
Digital
Manifolds
Vacuum
Pumps
Recovery
Scales
Digital
Gauges
Leak
Detection
Manifolds/
Gauges
Hoses
Mini-Split
Tool Kits
SHIELD
CoreMax
Access
Valves
Brass
Fittings
Ball
Valves
Just Better
Tools
Capillary
Tubing
Automotive/
LA-CO
Warranty/
Repair
Index/
Contacts

VACUUM PUMPS & ACCESSORIES

JB INDUSTRIES

PLATINUM®

Premium Vacuum Pumps

- 2-Stage direct drive with 1/2 HP capacitor start and thermal overload protection
- Available in 1.5, 3, 5, 7 and 10 CFM
- Easy access 1/4", 3/8" or 1/2" intake tee
- 15 micron vacuum rating
- Gas ballast and blank-off isolation valve
- All-metal construction with finned aluminum heavy-duty housing, brass fittings, stainless steel valving and splash guard
- Ergonomic 1/2" NPT break-resistant exhaust handle with lift ring
- Large, easy-to-see oil level sight glass with easy access oil fill
- O-ring sealed oil drain valve to prevent leaks and tethered safety cap to prevent oil spills
- Internal check valve prevents oil back-flow during power failure
- 100% field repairable; see page 74 for repair parts
- Available in 115v or dual voltage motor with switch (115v/230v)
- Removable, interchangeable power cord on dual voltage motors
- 2 year OTC warranty
- Made in the USA 

Spark-Proof Pump

Spark-proof, dual voltage motor with switch and removable, interchangeable power cord for use on Class A1, A2L, A2 and A3 refrigeration systems, **DV-200N-250SP**

International Dual Voltage Pump

PLATINUM® -250 and -250SP Series models feature a dual voltage motor with switch and removable, interchangeable power cord. Specify US, EU, UK, AU or BR plug type.



DV-200N-250SP
Spark-Proof

Are you ready to shed some weight?

Just in time for your summer rush, JB is developing a lightweight, DC, 8.4 CFM Pump. Forged from American steel, and manufactured in Aurora, IL, this new DC Pump is tough, versatile, and powerful enough to pull a deep vacuum on virtually any size system. Follow us on social media for news on availability.



PLATINUM® DV-240DC	
CFM	8.4 CFM
MOTOR	1 HP, DC
VOLTAGE	115v/230v
INTAKE PORT	1/2" x 1/4" x 3/8"
OIL CAPACITY	21 oz
WEIGHT	27 lb



COMING SOON!



PLATINUM® PUMPS						
	DV-42N	DV-85N	DV-142N	DV-200N	DV-285N	
CFM	1.5 CFM (42 l/m)	3 CFM (85 l/m)	5 CFM (142 l/m)	7 CFM (200 l/m)	10 CFM (285 l/m)	
MOTOR	1/2 HP, 1725 RPM	1/2 HP, 1725 RPM	1/2 HP, 1725 RPM	1/2 HP, 1725 RPM	1/2 HP, 1725 RPM	
VOLTAGE	115v/60Hz	115v/60Hz	115v/60Hz	115v/60Hz	115v/60Hz	
INTAKE PORT	1/4"	1/4" x 3/8"	1/2" x 1/4" x 3/8"	1/2" x 1/4" x 3/8"	1/2" x 1/4" x 3/8"	
OIL CAPACITY	26oz (769cc)	26oz (769cc)	26oz (769cc)	21oz (621cc)	21oz (621cc)	
SHIPPING DIMS	17-5/8" x 9-1/8" x 14"	17-5/8" x 9-1/8" x 14"	17-5/8" x 9-1/8" x 14"	17-5/8" x 9-1/8" x 14"	17-5/8" x 9-1/8" x 14"	
WEIGHT	29lbs (13.2kg)	30lbs (13.6kg)	32lbs (14.5kg)	32lbs (14.5kg)	34lbs (15.4kg)	
PLATINUM® DUAL VOLTAGE AND SPARK-PROOF PUMPS						
	DV-42N-250	DV-85N-250	DV-142N-250	DV-200N-250	DV-200N-250SP SPARK-PROOF	DV-285N-250
MOTOR	1/2 HP, 1725/1425 RPM	1/2 HP, 1725/1425 RPM	1/2 HP, 1725/1425 RPM	1/2 HP, 1725/1425 RPM	1/2 HP, 1725/1425 RPM	1/2 HP, 1725/1425 RPM
VOLTAGE	115v/60Hz, 230v/50Hz	115v/60Hz, 230v/50Hz	115v/60Hz, 230v/50Hz	115v/60Hz, 230v/50Hz	115v/60Hz, 230v/50Hz	115v/60Hz, 230v/50Hz
PLUG OPTIONS*	US/EU/UK/AU/BR	US/EU/UK/AU/BR	US/EU/UK/AU/BR	US/EU/UK/AU/BR	US/EU/UK/AU/BR	US/EU/UK/AU/BR

ELIMINATOR®

USA Made Economy Vacuum Pump

- 2-Stage direct drive with 1/2 HP 1725 RPM motor
- Available in 3, 4 and 6 CFM
- Easy access 1/4" or 3/8" intake tee
- 25 micron vacuum rating
- All-metal construction with burnished cover, brass fittings and stainless steel valving
- Ergonomic 1/2" break-resistant exhaust handle
- Large, easy-to-see oil level sight glass with easy access oil fill
- Tethered safety cap to prevent oil spills
- 100% field repairable; see page 76 for repair parts
- Available in 115v or dual voltage motor with switch (115v/230v)
- Removable, interchangeable power cord on dual voltage motors
- 2 year OTC warranty
- Made in the USA 



DV-6E

Spark-Proof Pump

Spark-proof, dual voltage motor with switch and removable, interchangeable power cord for use on Class A1, A2L, A2 and A3 refrigeration systems, **DV-6E-250SP**

International Dual Voltage Pump

ELIMINATOR® -250 and -250SP Series models feature a dual voltage motor with switch and removable, interchangeable power cord. Specify US, EU, UK, AU or BR plug type.



DV-6E-250SP
Spark-Proof



ELIMINATOR® PUMPS				
	DV-3E	DV-4E	DV-6E	
CFM	3 CFM (85 l/m)	4 CFM (113 l/m)	6 CFM (170 l/m)	
MOTOR	1/2 HP, 1725 RPM	1/2 HP, 1725 RPM	1/2 HP, 1725 RPM	
VOLTAGE	115v/60Hz	115v/60Hz	115v/60Hz	
INTAKE PORT	1/4" x 3/8"	1/4" x 3/8"	1/4" x 3/8"	
OIL CAPACITY	28oz (828cc)	25oz (739cc)	25oz (739cc)	
SHIPPING DIMS	17-5/8" x 9-1/8" x 14"	17-5/8" x 9-1/8" x 14"	17-5/8" x 9-1/8" x 14"	
WEIGHT	29lbs (13.2kg)	30lbs (13.6kg)	30lbs (13.6kg)	
ELIMINATOR® DUAL VOLTAGE				
	DV-3E-250	DV-4E-250	DV-6E-250	DV-6E-250SP
MOTOR	1/2 HP, 1725/1425 RPM	1/2 HP, 1725/1425 RPM	1/2 HP, 1725/1425 RPM	1/2 HP, 1725/1425 RPM
VOLTAGE	115v/60Hz, 230v/50Hz	115v/60Hz, 230v/50Hz	115v/60Hz, 230v/50Hz	115v/60Hz, 230v/50Hz
PLUG	US 220v	US 220v	US 220v	US 220v
PLUG OPTIONS*	US/EU/UK/AU/BR	US/EU/UK/AU/BR	US/EU/UK/AU/BR	US/EU/UK/AU/BR

*Specify plug type when ordering; -250 for US, -250EU for EU, -250UK for UK.

VACUUM PUMPS & ACCESSORIES

JB INDUSTRIES

NEW

ACCELERATOR

VL-200 Rapid Evacuation Kit

The VL-200 ACCELERATOR Rapid Evacuation Kit paired with a JB vacuum pump allows technicians to remove restrictive valve cores and perform HVACR system evacuations up to 20x Faster.

UP TO
20x
FASTER
EVACUATIONS

- Y-FORCE Dual, High-speed Coupler Connector increases speed of evacuation
- 48" long, 1/2" diameter vacuum certified evacuation hose will not collapse or permeate
- 1/4" valve core tool removes restrictive cores and maximizes flow; Vacuum rated to 20 microns
- Opens up over 90% of internal diameter of access port
- Slide valve easily attaches and protects vacuum gauge with the slide valve side port
- Made in the USA 🇺🇸



Easily attaches and protects vacuum gauge with the slide valve side port



Increase speed of evacuation with the Y-FORCE Coupler Connector and two large diameter hoses

PART NO.	DESCRIPTION
VL-200	ACCELERATOR evacuation kit with A32525N, A32525SV, QC-208, QC-206, CL264-48 (2) and convenient storage bag
REPLACEMENT PART NO.	DESCRIPTION
A32525SV	Valve Core Removal Tool with Slide Valve Side Port
A32525N	Valve Core Removal Tool
QC-206	(3/8") Y-FORCE Dual, High-Speed Coupler Connector
QC-208	(1/2") Y-FORCE Dual, High-Speed Coupler Connector
CL264-48	(2) 48" long, 1/2" diameter evacuation hose with 3/8" x 1/4" SAE female swivel hose connections
P325	1/4" and 5/16" replacement gaskets for A32525N (1 each)



CL264-48

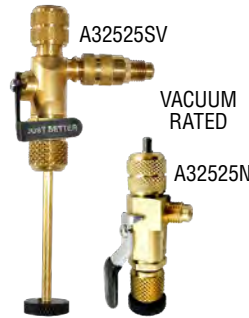

3/8" 3/8" 3/8" 3/8"



QC-208 (1/2") QC-206 (3/8")



Convenient drawstring storage bag

VELOCITY

VL-100 Rapid Evacuation Kit

The VL-100 VELOCITY Rapid Evacuation Kit paired with a vacuum pump allows technicians to remove restrictive valve cores and perform HVACR system evacuations up to 10x Faster.

UP TO
10x
FASTER
EVACUATIONS

- 60" long, 1/2" diameter evacuation hose
- 1/4" Valve Core Tool removes restrictive cores; vacuum rated to 20 microns
- Opens up over 90% of internal diameter of access port
- Vacuum certified hose will not collapse or permeate
- Made in the USA 🇺🇸

PART NO.	DESCRIPTION
VL-100	VELOCITY evacuation kit with hose and valve core removal tool
REPLACEMENT PART NO.	DESCRIPTION
A32525N	Valve core removal tool
CL264-60	(1) 60" long, 1/2" diameter hose; 3/8" x 1/4" SAE flare
P325	1/4" and 5/16" replacement gaskets for A32525N (1 each)



CL264-60

A32525N
Valve Core
Removal Tool

Y-FORCE

NEW

Dual, High-Speed Coupler Connectors

Work faster with the Y-FORCE Dual, High-Speed Coupler Connector available with a 3/8" or 1/2" connection.

- Speed up evacuation with dual hose connections; Easily connects two hoses to one point
- Vacuum rated and designed for high-pressure refrigerants
- Rugged solid brass construction
- Use with any vacuum pump
- Made in the USA 



Increase speed of evacuation with the Y-FORCE Dual, High-speed Coupler Connector and two large diameter hoses.

PART NO.	DESCRIPTION
QC-206	3/8" x 3/8" x 3/8"
QC-208	3/8" x 3/8" x 1/2"

DV-T1

NEW

The TANK Vacuum Pump Oil Container

Changing the oil after every job will extend the life of your vacuum pump and clean oil ensures peak pump efficiency and deep vacuum.

- Holds up to 10 quarts
- No mess, No spills
- Corner hand grips for easy handling
- Stores upright or flat with no spills
- Environmentally friendly
- Made in the USA 



PART NO.	DESCRIPTION
DV-T1	The TANK Vacuum Pump Oil Caddy

BLACK GOLD®

Pump Oil

- Acts as a coolant, lubricant and sealant—simultaneously. Non-detergent, hydro-processed
- Made in the USA 



PART NO.	QTY.	DESCRIPTION
DVO-1	24	BLACK GOLD pint case
DVO-12	12	BLACK GOLD quart case
DVO-24	6	BLACK GOLD gallon case

Oil Mist Filter

Eliminates oil mist from pump handle

- Made in the USA 



DV-F8

PART NO.	DESCRIPTION
DV-F6	Oil mist filter 3/8"; ELIMINATOR (pre-2011) and PLATINUM (pre-2008)
DV-F8	Oil mist filter 1/2"; ELIMINATOR (2011+) and PLATINUM (2000+)

Quick Couplers

- Features o-ring seal and no depressor
- Made in the USA 



QC-E64

PART NO.	DESCRIPTION
QC-E64	3/8" QC x 1/4" SAE elbow
QC-S64	3/8" QC x 1/4" SAE straight
P90009	1/4" Replacement o-ring (10 pack)
P90012	3/8" Replacement o-ring (10 pack)

Shutoff Valve

- O-ring quick coupler shutoff valves for blanking off vacuum system; pressures up to 800lbs
- Made in the USA 



D10162

PART NO.	DESCRIPTION
D10162	1/4" Female QC x 1/4" flare

Swivel Couplers

- Features an o-ring seal
- Made in the USA 

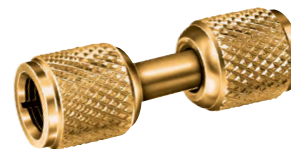

D10244

PART NO.	DESCRIPTION
D10244	1/4" Female swivel coupler
D10266	3/8" Female swivel coupler
P90009	1/4" Replacement o-ring (10 pack)
P90012	3/8" Replacement o-ring (10 pack)

F6-BOOST

NEW

BLDC Ignition-Proof Refrigerant Recovery Machine

The F6-BOOST Refrigerant Recovery Machine provides over 20% faster recovery rates than competitor models. The unique 2-cylinder, oilless compressor and long-lasting pistons are contained in a lightweight, ergonomically designed, easy-to-use unit. The F6-BOOST gives the user fast and reliable refrigerant recovery.

**20%^{OVER}
FASTER
THAN COMPETITION***

FEATURES

- Dual voltage (100-240VAC 50/60Hz)
- Powerful 1.25 HP BLDC (Brushless DC) motor-driven oilless compressor
- Ignition-proof design tested and approved to ISA 12.12.01:2016 Ed.7
- High air-flow fan with a micro-channel condenser keeps the unit running cool
- Variable speed motor (based on load)
- 2-piece, oilless piston-seal design with long-lasting, durable elastomer, easy-to-replace piston seals
- Non-pressurized vented crank case (prevents refrigerant from damaging bearings or seals)
- Built-in purge functionality (self-clearing or pump down) to prevent cross-contamination
- High-pressure 550 PSIG cutout switch
- Easy-to-use interface with 2-1/4" high/low gauges
- Auto shut-off when recovery is complete
- Status indicator light
- Compact lightweight 23.5lb unit with robust, high-impact, injection-molded case
- Recessed folding handle with rubber grip and padded shoulder strap
- 10' locking power cable and velcro cord wrap
- 1 year OTC warranty / 2 year return and repair; Use this device to recover only HVACR refrigerants from sealed HVACR systems. Warranty voided if used for any other purpose.



PART NO.	DESCRIPTION
F6-BOOST	BLDC Ignition-Proof Refrigerant Recovery Machine



Unit has rugged recessed handle for storage, locking cable and velco cord wrap. Knock-out location for optional tank overflow switch (sold separately).

*Speed based on vapor recovery for certain refrigerants.



Refrigerant Recovery Machine

- Full one horsepower motor
- Powerful dual piston compressor
- Self-purge without changing hoses
- Simple two-valve operation
- Micro-channel condenser for industry-leading recovery rates
- Oversized cooling fan for superior heat dissipation
- Full-size protected gauges for suction and tank pressure
- Heavy-duty handle with comfortable rubber grip and detachable power cord
- Filter/drier included
- 3 year OTC warranty

Refrigerant Recovery Tanks

- For safely storing or transporting refrigerant
- Available in 30lb and 50lb tanks



Recovery Safety

- Refrigerant should be recovered by trained professionals only
- Wear protective gear, gloves and eye protection
- Never mix refrigerants
- Do not overfill tanks past 80% capacity

Use Proper Equipment

Use a refrigerant scale such as JB's DS-250 to ensure proper refrigerant measurement.



PART NO.	DESCRIPTION
F6-DP	F6 Refrigerant Recovery Machine (115v)
F6-DP-250	F6 Refrigerant Recovery Machine (230v)
REC-TANK-30	30lb Empty refrigerant tank cylinder
REC-TANK-50	50lb Empty refrigerant tank cylinder
REPLACEMENT PART NO.	DESCRIPTION
F6-FLT	Filter/drier attachment
F6-STRAP	Carrying strap
F6-BH	Blue knob and screw
F6-RH	Red knob and screw
F6-110-CRD	Power cord
F6-RBFT	Rubber foot
F6-RHP	Gauges



- Carrying strap with shoulder pad
- Heavy-duty metal handle with comfortable rubber grip
- Rugged blow-molded outer shell
- Recessed gauges
- Sturdy metal knobs
- Easy access filter
- Self-purge without changing hoses
- Micro-channel condenser for industry-leading recovery rates
- Large fan for superior heat dissipation
- Circuit breaker
- Detachable and replaceable power cord for easy maintenance

NEW

ATLAS DS-5000 Propane Scale

- Back-lit LCD display
- Large weighing platform
- Durable and sturdy injected molded components
- High accuracy load cell
- Pass-through charging (moving the charge hose does not affect weight)
- Small diameter durable CLRF Series hoses included
- Charging valve included for precision charging
- Schrader valves included to prevent refrigerant loss/leaks
- Cylinder adapter with Secure Seal low-loss fitting included for inverted charging
- 2 charging orientation options: upright and inverted
- Velcro loop included for stabilizing the refrigerant canister (upright charging)
- Designed for R600a and R290
- Other charging methods are possible by using additional adapters for different canister types
- 1 year warranty



PART NO.	DESCRIPTION
DS-5000	ATLAS Propane Scale with two CLRF-18Y Series hoses, MBV4-01 Mini Ball-valve fitting, Propane cylinder adapter, Velcro loop and case.

Specifications

Capacity	5000g / 176oz
Accuracy	1g / 0.1oz
Power Supply	Two AA batteries (included)
Dimensions	(L x W x H) 7.9" x 5.9" x 1.9" (200mm x 150mm x 48mm)

ATLAS DS-5000 Propane Scale

Inverted Charging:

1. Connect the charging hose to the scale side port.
2. Connect the other end of the charging hose (with the charging valve closed) to the system.
3. Attach the secure-seal adapter fitting to the refrigerant canister.
4. Invert the can and connect the secure seal fitting to the fitting on the scale platter.
5. Turn on the scale. Scale will display combined weight of cylinder and gas.
6. Short press the TARE button to zero the scale.
7. Charge the system by throttling the charging valve and monitoring the scale weight.
8. Once the proper weight is transferred from the canister to the system close the charging valve and remove the charging hose from the system.

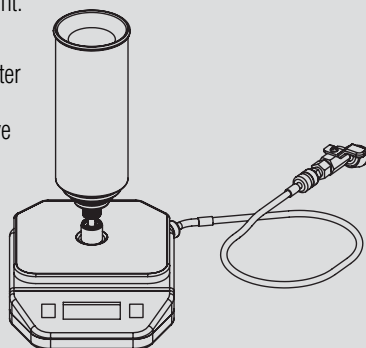

Upright Charging:

1. Connect the charging hose to the scale side port.
2. Connect the other end of the charging hose (with the charging valve closed) to the system.
3. Attach can tap to the refrigerant canister (Can tap should not release refrigerant).
4. Connect one end of the hose to the can tap.
5. Connect the other end of the hose to the scale platter fitting.
6. Use Velcro loop to secure the can to the hose and stabilize the can on the scale platter.
7. Open the can tap valve to release the refrigerant.
8. Turn on the scale. Scale will display combined weight of cylinder and gas.
9. Short press the TARE button to zero the scale.
10. Charge the system by throttling the charging valve and monitoring the scale weight.
11. Once the proper weight is transferred from the canister to the system close the can tap and charging valve and remove the charging hose from the system.

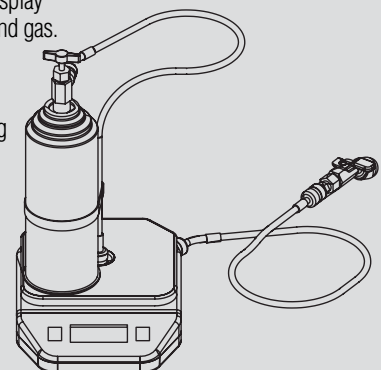

PRO TIPS



NEW

ATLAS DS-250

Wireless Digital Refrigerant Scale with Wired Handset

- Wireless connection to smart devices via DS-250 app available through **JB GO**
- Wired, full-color, LCD display on removable handset
- Job time recording/data logging with email capability
- Wired handset with built-in magnets and hanging hook
- Programmable weight alarms
- Adjustable units of measurement
- Selectable auto-shutoff
- Slip-resistant platform and water-resistant design
- Durable, blow-molded case
- Safe for use with A2L refrigerants
- 2 year warranty

Specifications

Capacity	250lb (113kg)
Resolution	0.25 oz
Display units	lb/oz, oz, lb, kg
Operating Temperature	+32°F to 122°F (0°C to +50°C)
Storage Temperature	+14°F to 140°F (-10°C to +60°C)
Humidity	85% RH @113°F (45°C), non-condensing
Power Supply	Four AA batteries (included)
Battery Life	Approximately 58 hours
Accuracy	Minimum +/- 0.3% of reading +/- 10g
Bluetooth® Range	300ft (92m)



**WIRELESS
CONNECTIVITY &
EASY-TO-USE
REMOVABLE
WIRED HANDSET**



PART NO.	DESCRIPTION
DS-250	ATLAS Wireless Refrigerant Scale with Wired Handset

ATLAS DS-20000

Digital Refrigerant Scale

- Features all-metal construction, superior sensitivity and accuracy with replaceable parts
- Highly sensitive, solid-state load cell (0.25oz/10g)
- Easy-to-read LCD screen
- Field repairable with replaceable cable, weighing platform and handheld remote
- Displays weight in decimal/pounds, pounds/ounces and kilograms
- Automatic shutoff option to conserve battery life
- Protective carrying case
- 2 year warranty

Specifications

Capacity	220lb (100kg)
Operating Temperature	+32°F to 122°F (0°C to +50°C)
Storage Temperature	+14°F to 140°F (-10°C to +60°C)
Humidity	85% RH @113°F (45°C), non-condensing
Power Supply	One 9v battery (included)
Battery Life	Approximately 60 hours



PART NO.	DESCRIPTION
DS-20000	ATLAS Digital Refrigerant Scale in case
REPLACEMENT PART NO.	DESCRIPTION
DSR-10	Communication cable
DSR-20	Handheld remote
DSR-30	Weighing platform

DV-22N/DV-24N

Digital Vacuum Gauge

- Factory calibrated extended range MEMS sensor; vacuum reading range 100,000 to 10 microns
- Easy-to-read back-lit display
- Working temperature +32°F to 120°F (+0°C to 48.9°C)
- Allows for direct connection to A/C unit without a hose
- Intuitive user menu with custom setting options; Audible and visual alarms when target vacuum level is achieved
- Low battery indicator with automatic shutoff
- Measures in microns, psia, inHg, pascals, Torr, mTorr and mBar
- Operates with three AA batteries (included)
- Available with protective carrying case as DV-24N
- 1 year warranty



PART NO.	DESCRIPTION
DV-22N	Digital vacuum gauge
DV-24N	DV-22N with protective carrying case
REPLACEMENT PART NO.	DESCRIPTION
DV-27N	Protective carrying case only
DV-FILTER	Depressor and gasket with filter
P511	Gasket (6 pack)
P511-10	Gasket (10 pack)
P90009	O-ring for older models with o-ring (10 pack)

DVR-22

NEW

Digital Vacuum Gauge

- Measures vacuum levels in HVACR equipment
- Brass female 1/4" flare fitting easily attaches to common system fittings; Includes an angled adapter fitting for alternate positioning and improved visibility
- Large back-lit LCD display is easy to read
- Intuitive design saves the lowest vacuum reading
- Adjustable auto-off feature, long run-times and battery life indicator
- Four button interface offers easy setting adjustments
- Durable plastic housing
- Thermistor sensor for accurate vacuum measurements and easy cleaning
- 1 year warranty
- Made in the USA 

Specifications

Vacuum Range	10,000 micron – 20 microns
Accuracy	+/- 20% between 10,000 and 1000 microns +/- 15% below 1000 micron
Resolution	Varies based on depth of vacuum. 1 micron resolution (below 70 microns)
Sensor type	Thermistor
Vacuum units	Microns, Torr, mTorr, PSIA, mBar, Pascals, InHg
Power Supply	Three AA batteries (included)
Battery Life	Approximately 90 hours
Operating Temperature	+32°F to 122°F (0°C to +50°C)
Storage Temperature	+14°F to 140°F (-10°C to +60°C)
Humidity	85% RH @113°F (45°C), non-condensing
Display	Backlit LCD
Unit weight	9.5 oz



PART NO.	DESCRIPTION
DVR-22	Digital Vacuum Gauge
REPLACEMENT PART NO.	DESCRIPTION
P511	Gasket (6 pack)
P90514	Depressor (5 pack)

DV-41

SUPERNOVA® Digital Vacuum Gauge

- Fully programmable gauge includes approach and leak alarm settings with automatic shutoff and backlight duration
- Vacuum reading range 100,000 to 10 microns
- Measures in microns, psia, inHg, pascals, Torr, mTorr and mBar
- Easy-to-read LCD screen
- Factory calibrated
- 1/4" SAE flare brass fitting with flexible five-foot cord for hard-to-reach spaces
- Operates with AC adapter (included) or three AA batteries
- Protective carrying case
- 1 year warranty



PART NO.	DESCRIPTION
DV-41	Digital vacuum gauge with AC adapter and protective carrying case
REPLACEMENT PART NO.	DESCRIPTION
DV-40C	AC adapter and protective carrying case only
DV-40AC	AC adapter
DV-40HK	Hanging hook replacement
A34000D	1/4" QC x 1/4" access tee with depressor
DV-FILTER	Depressor and gasket with filter
P511	Gasket (6 pack)
P511-10	Gasket (10 pack)
P90009	O-ring for older models with o-ring (10 pack)

SH-35N

Wireless Gauge for Superheat and Subcooling

- Wirelessly connects to smart devices with SH-35N app through **JB GO**; share screenshots right from your phone
- OLED sunlight-readable screen
- Protective carrying case
- Built-in valve port to easily adjust refrigerant charge
- Range up to 400ft (unobstructed)
- Rechargeable lithium polymer battery
- 50+ Refrigerants
- 1 year warranty

Specifications

Operating Temperature	14°F to 122°F (-10°C to 50°C)
Storage Temperature	-4°F to 140°F (-20°C to 60°C)
Pressure Range	-14.7 psi to 670 psi
Pressure Accuracy	+/- 0.5%FS
Temperature Range	-58°F to 302°F (-50°C to 150°C)
Temperature Accuracy	+/- 1.2%FS



PART NO.	DESCRIPTION
SH-35N	Digital wireless gauge for superheat/subcooling includes temperature clamp, power charger and protective carrying case
REPLACEMENT PART NO.	DESCRIPTION
SH-35-CL	Temperature clamp
SH-35N-CS	Protective carrying case
P511	Gasket (6 pack)
P511-10	Gasket (10 pack)

Using a Vacuum Gauge How to Measure Evacuation

Digital vacuum gauges can precisely read the low pressures produced when evacuation/dehydration is complete. Evacuation is complete when a system holds at 500 microns. Although a compound gauge can indicate that a vacuum is being produced, it cannot measure pressure accurately or indicate whether moisture or contaminants remain in the system. A digital vacuum gauge can positively indicate that the system is free of leaks and non-condensables.

Placement of the digital vacuum gauge is important. The ideal location to measure vacuum is at the system not the pump. Attach the digital vacuum gauge directly to the system isolating the gauge from the pump, hoses and manifold for accurate measurement of the vacuum in a system.

For faster evacuation time and to achieve optimum pump performance:

1. Select the correct pump CFM.
2. Use clean oil and be sure to change pump oil with **BLACK GOLD** Vacuum Pump Oil after each use. Clean oil improves pump efficiency and extends pump life.
3. Remove restrictive valve cores from both high and low side fitting with the **A32525N** or **A32500N** valve core tools.
4. Evacuate both high and low sides of the system simultaneously with a short 3/8" diameter or larger size evacuation hose, such as the **VL-100 VELOCITY** Rapid Evacuation Kit.
5. Attach a digital vacuum gauge directly to the system to monitor accurate measurement of vacuum.

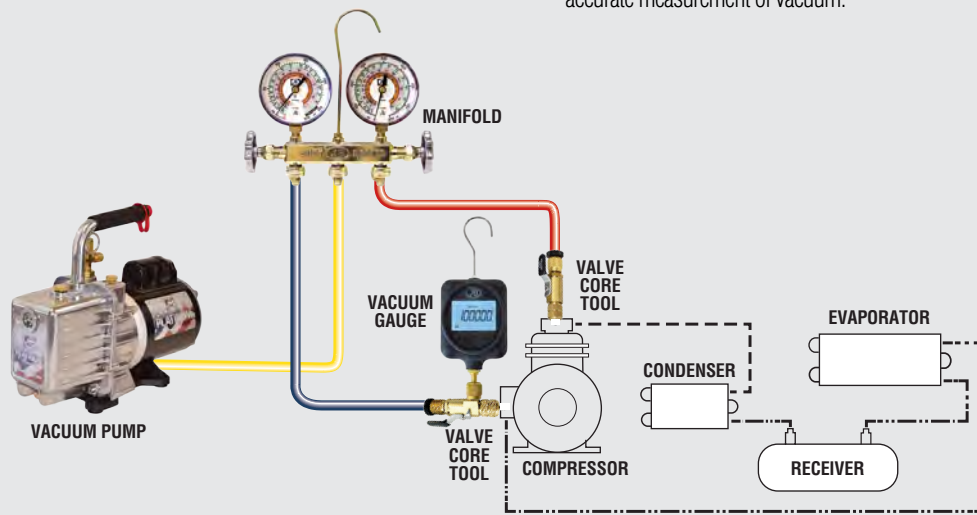

DV-29 Vacuum Gauge Blank-off Test Kit

The **DV-29** Vacuum Gauge Blank-off Test Kit works with vacuum gauges and the **SH-35N** Wireless Digital Gauge for Superheat and Subcooling to create a closed system ideal for checking leaks.

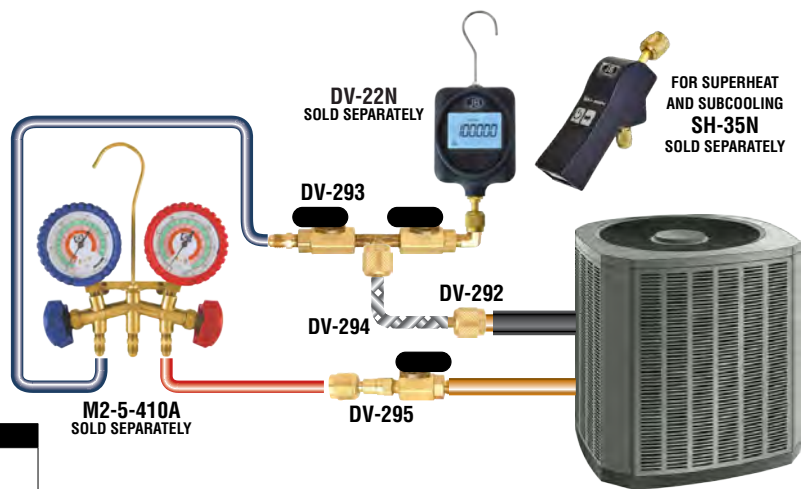

PART NO.	DESCRIPTION
DV-29	Leakproof micron hook-up test kit Includes: DV-292, DV-293, DV-294 and DV-295
REPLACEMENT PART NO.	DESCRIPTION
DV-291	1/4" SAE swivel coupler (D10244)
DV-292	90° male flare with 1/4" o-ring QC
DV-293	Valve assembly 1/4" MFL connector
DV-294	10" (25.4 cm) metal hose with o-ring
DV-295	Ball valve with o-ring QC and depressor
P90009	O-ring (10 pack)

LD-5000

PROWLER® Electrochemical Refrigerant Leak Detector

- Detects all HFC, HCFC, HFO and blended refrigerants
- Sensor life > 10 years; proprietary electrochemical sensor will not diminish over time or with use
- Manual calibration mode and reset control
- High, medium and low sensitivity settings
- Warm-up time < 30 seconds; response time immediate
- Mutable alarm with a silent vibrating handle
- Back-lit LCD screen tilts up for easy viewing at any angle
- 17" flexible probe
- Protective carrying case
- Operates with four AA batteries (included)
- 2 year warranty
- Made in the USA with globally sourced parts 



PART NO.	DESCRIPTION
LD-5000	PROWLER Leak Detector in Case
REPLACEMENT PART NO.	DESCRIPTION
LD-S101	Sensor (6 prong)
LD-RF5	Filters (5 pack)
LD-TV	Leak test vial
LD-PK	Parts kit (includes 6 prong sensor, filter kit and test vial)
LD-CS	Protective carrying case
LD-ST	Sensor tip

LDC-4000

Combustible Gas and HC Refrigerant Leak Detector

- High sensitivity to all HC refrigerants and combustible gases
- Long life solid-state heated sensor
- Sensitive to < 5 ppm of methane
- Sensor life > 300 hours
- Automatic calibration and reset to ambient
- Comfortable rubber handle
- Intrinsically safe certified
- Low battery indicator
- 17" flexible probe
- Protective carrying case
- Operates with four AA batteries (included)
- 2 year warranty



PART NO.	DESCRIPTION
LDC-4000	Combustible Gas and HC Refrigerant Leak Detector in Case
REPLACEMENT PART NO.	DESCRIPTION
LDC-4000-1	Sensor (4 prong)
LDC-4000-2	Sensor cover
LDC-4000-3	Combustible leak test vial
LDC-4000-4	Protective carrying case

LD-3000

QUEST Electrochemical Refrigerant Leak Detector

- Long life electrochemical sensor
- Detects all CFC, HFC, HFO, HCFC refrigerants and hydrocarbon blends
- Automatic calibration and reset to ambient levels
- Three adjustable sensitivity levels
- Low battery indicator
- Mutable alarm function
- Comfortable rubber handle
- 18" flexible probe
- Protective carrying case
- Operates with four AA batteries (included)
- 2 year warranty
- Made in the USA with globally sourced parts 



PART NO.	DESCRIPTION
LD-3000	QUEST Leak Detector in Case
REPLACEMENT PART NO.	DESCRIPTION
LD-S101	Sensor (6 prong)
LD-RF5	Filters (5 pack)
LD-TV	Leak test vial
LD-PK	Parts kit (includes 6 prong sensor, filter kit and test vial)
LD-CS	Protective carrying case
LD-ST	Sensor tip

PATRIOT™ 2-Valve Brass Manifold

- Rugged bar design paired with easy-to-grip metal handles
- Available with assorted gauge options
- Free-floating, dual o-ring sealing system for faster evacuation and charging
- Surge dampened gauges for reduced needle movement
- 360° swiveling hose holders
- Secure hanging hook
- Easy-to-turn metal handwheels
- Solid brass forging
- 1 year warranty; lifetime on bar
- Made in the USA 

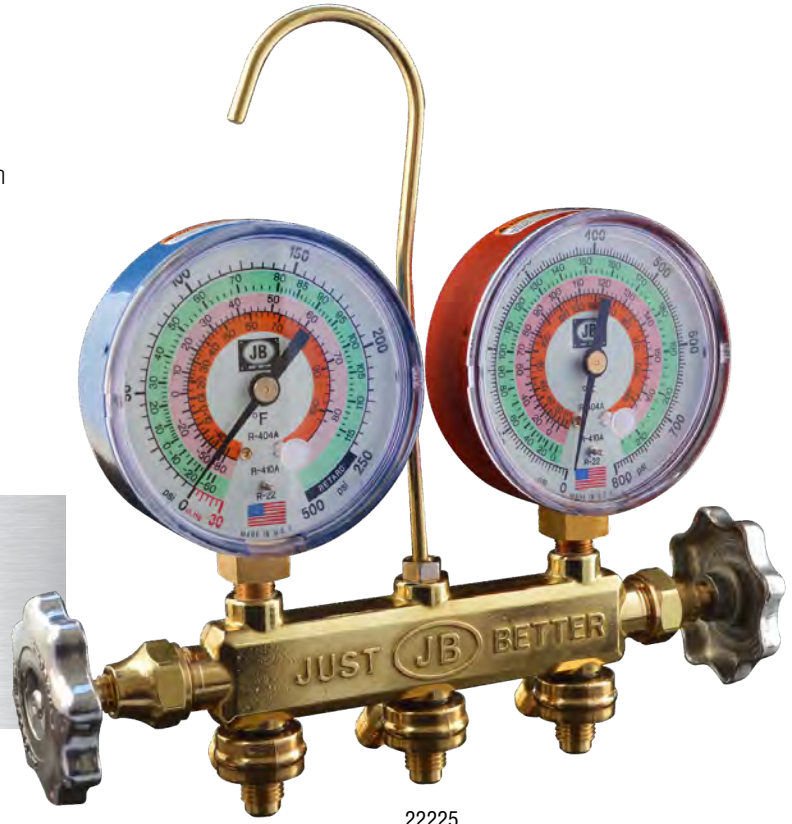

The Manifold that Gives Back



For each PATRIOT™, MSKIT1 or MSKIT2 sold JB will donate to Operation Homefront. To learn more about Operation Homefront visit www.operationhomefront.net



PART NO.	HOSES	GAUGE SIZE	GAUGE FEATURES
22225	Manifold Only	3-1/8" (80mm)	Illuminating Class 1, 1%
22225L	Manifold Only	3-1/8" (80mm)	LED, Class 1, 1%
22225CM	Manifold Only	3-1/8" (80mm)	Illuminating, Class 1, 1% Camo
22233	CCLC-60"	3-1/8" (80mm)	Illuminating, Class 1, 1%
22233L	CCLC-60"	3-1/8" (80mm)	LED, Class 1, 1%
22233CM	CCLC-60"	3-1/8" (80mm)	Illuminating, Class 1, 1% Camo
22246	CCLS-60"	3-1/8" (80mm)	Illuminating, Class 1, 1%
22246CM	CCLS-60"	3-1/8" (80mm)	Illuminating, Class 1, 1% Camo

PART NO.	HOSES	GAUGE SIZE	GAUGE FEATURES
22125	Manifold Only	3-1/8" (80mm)	Illuminating, Class 1, 1%
22133	CCLC-60"	3-1/8" (80mm)	Illuminating, Class 1, 1%

PART NO.	HOSES	GAUGE SIZE	GAUGE FEATURES
22500	Manifold Only	2-1/2" (63.5mm)	R410A Only
22505	Manifold Only (5/16")	2-1/2" (63.5mm)	R410A Only
22525	Manifold Only	3-1/8" (80mm)	R410A Only
22531	CCLC-60"	3-1/8" (80mm)	R410A Only

PART NO.	HOSES	GAUGE SIZE	GAUGE FEATURES
22725	Manifold Only	3-1/8" (80mm)	Illuminating, Class 1, 1% Hydrocarbon
22733	CCLC-36"	3-1/8" (80mm)	Illuminating, Class 1, 1% Hydrocarbon
22733RF-18	18" CLRH Hoses	3-1/8" (80mm)	Illuminating, Class 1, 1% Hydrocarbon

PART NO.	HOSES	GAUGE SIZE	GAUGE FEATURES
22633	CCLC-60"	3-1/8" (80mm)	Illuminating, Class 1, 1% Hydrocarbon
22600	Manifold Only	3-1/8" (80mm)	Illuminating, Class 1, 1% Hydrocarbon
22605	Manifold Only (5/16")	3-1/8" (80mm)	Illuminating, Class 1, 1% Hydrocarbon

PART NO.	HOSES	GAUGE SIZE	GAUGE FEATURES
22833	CCLC-60"	3-1/8" (80mm)	Illuminating, Class 1, 1% Hydrocarbon

PART NO.	HOSES	GAUGE SIZE	GAUGE FEATURES
22933	CCLC-60"	3-1/8" (80mm)	Illuminating, Class 1, 1% Hydrocarbon

PART NO.	HOSES	GAUGE SIZE	GAUGE FEATURES
22433	CCLC-60"	1-1/2" (63.5mm)	Illuminating, Class 1, 1% Hydrocarbon

Additional manifold gauge options, refrigerant combinations and accessories available on page 29. Hose options available begin on page 30. Manifold rebuild kits and repair parts on page 77.

NEW

REVOLVER®

4-Valve Ball Valve Manifold

- Integrated liquid charging capability
- Adjusts to finite openings for liquid charging
- Quarter-turn full open/close handle
- 3/8" port for faster evacuation
- Available with 2-1/2" and 3-1/8" size gauges
- 360° swiveling hose holders for greater flexibility
- Replaceable durable hanging hook
- Surge dampened all-metal gauges for reduced needle movement
- 1 year warranty; lifetime on bar
- Made in the USA 

Liquid Charging

1. Full Open



2. Liquid Charging



3. Closed

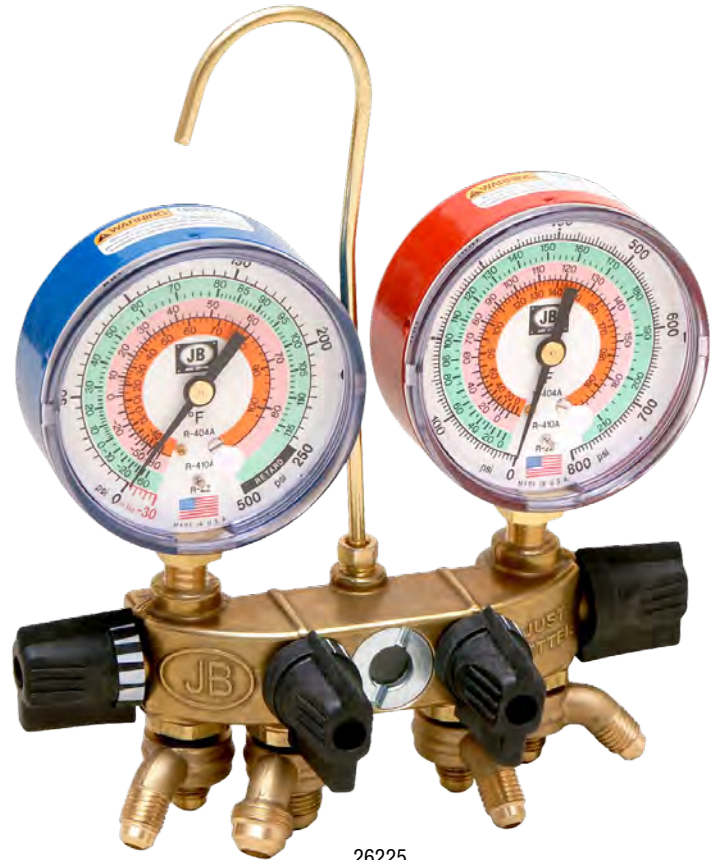

26225

R22		R404A		R410A	
PART NO.	HOSES	GAUGE SIZE	GAUGE FEATURES		
26200	Manifold Only	2-1/2" (63.5mm)	Standard		
26225	Manifold Only	3-1/8" (80mm)	Illuminating		
26225L	Manifold Only	3-1/8" (80mm)	LED		
26208	CCL4-60"	2-1/2" (63.5mm)	Standard		
26233	CCL4-60"	3-1/8" (80mm)	Illuminating		
26233L	CCL4-60"	3-1/8" (80mm)	LED		
26240	CCLV4-60"	3-1/8" (80mm)	Illuminating		
26244	CCLV4-60"	3-1/8" (80mm)	Illuminating		
26246	CCLS-60"	3-1/8" (80mm)	Illuminating		

R12		R22		R502	
PART NO.	HOSES	GAUGE SIZE	GAUGE FEATURES		
26000	Manifold Only	2-1/2" (63.5mm)	Standard		
26025	Manifold Only	3-1/8" (80mm)	Illuminating		
26008	CCL4-60"	2-1/2" (63.5mm)	Standard		
26033	CCL4-60"	3-1/8" (80mm)	Illuminating		
26040	CCLV4-60"	3-1/8" (80mm)	Illuminating		
26044	CCLS-60"	3-1/8" (80mm)	Illuminating		

R22		R134A		R404A	
PART NO.	HOSES	GAUGE SIZE	GAUGE FEATURES		
26100	Manifold Only	2-1/2" (63.5mm)	Standard		
26125	Manifold Only	3-1/8" (80mm)	Illuminating		
26108	CCL4-60"	2-1/2" (63.5mm)	Standard		
26133	CCL4-60"	3-1/8" (80mm)	Illuminating		
26140	CCLV4-60"	3-1/8" (80mm)	Illuminating		
26144	CCLS-60"	3-1/8" (80mm)	Illuminating		

Additional manifold gauge options, refrigerant combinations and accessories available on page 29. Hose options available begin on page 30. Manifold rebuild kits and repair parts on page 77.

ZEPPELIN®

2-Valve Aluminum Manifold

- Machined from durable, solid aluminum billets
- Rubber handwheels for improved grip and reduced turns to open/close
- Improved stem design—fully open in only 2-1/2 turns
- Surge dampened gauges for reduced needle movement
- Original free-floating dual o-ring sealing system for faster evacuation and charging
- Available with 2-1/2" and 3-1/8" size gauges
- Easy-to-read, color-coded refrigerant dials
- Replaceable, durable hanging hook
- Replaceable intake/hose holder fittings
- 1 year warranty; lifetime on bar
- Made in the USA 



24225

R22	R404A	R410A	
PART NO.	HOSES	GAUGE SIZE	GAUGE FEATURES
24200	Manifold Only	2-1/2" (63.5mm)	Standard
24250	Manifold Only	3-1/8" (80mm)	Liquid Filled, Class 1, 1%
24225	Manifold Only	3-1/8" (80mm)	Illuminating
24208	CCL-60"	2-1/2" (63.5mm)	Standard
24258	CCL-60"	3-1/8" (80mm)	Liquid Filled, Class 1, 1%
24233	CCL-60"	3-1/8" (80mm)	Illuminating
24265	CCLV-60"	3-1/8" (80mm)	Liquid Filled, Class 1, 1%
24240	CCLV-60"	3-1/8" (80mm)	Illuminating
24244	CCL-60"	3-1/8" (80mm)	Illuminating

R22	R134A	404A	
PART NO.	HOSES	GAUGE SIZE	GAUGE FEATURES
24100	Manifold Only	2-1/2" (63.5mm)	Standard
24150	Manifold Only	3-1/8" (80mm)	Liquid Filled, Class 1, 1%
24125	Manifold Only	3-1/8" (80mm)	Illuminating
24108	CCL-60"	2-1/2" (63.5mm)	Standard
24158	CCL-60"	3-1/8" (80mm)	Liquid Filled, Class 1, 1%
24133	CCL-60"	3-1/8" (80mm)	Illuminating
24165	CCLBV-60"	3-1/8" (80mm)	Liquid Filled, Class 1, 1%
24140	CCLBV-60"	3-1/8" (80mm)	Illuminating
24169	CCLS-60"	3-1/8" (80mm)	Liquid Filled, Class 1, 1%
24144	CCLS-60"	3-1/8" (80mm)	Illuminating

R22	R134A	R404A	R410A
PART NO.	HOSES	GAUGE SIZE	GAUGE FEATURES
24600	Manifold Only	3-1/8" (80mm)	Liquid Filled, Class 1, 1%
24608	CCL-60"	3-1/8" (80mm)	Liquid Filled, Class 1, 1%
24615	CCLBV-60"	3-1/8" (80mm)	Liquid Filled, Class 1, 1%

Additional manifold gauge options, refrigerant combinations and accessories available on page 29. Hose options available begin on page 30. Manifold rebuild kits and repair parts on page 77.

R12	R22	R502	
PART NO.	HOSES	GAUGE SIZE	GAUGE FEATURES
24000	Manifold Only	2-1/2" (63.5mm)	Standard
24050	Manifold Only	3-1/8" (80mm)	Liquid Filled, Class 1, 1%
24025	Manifold Only	3-1/8" (80mm)	Illuminating
24008	CCL-60"	2-1/2" (63.5mm)	Standard
24058	CCL-60"	3-1/8" (80mm)	Liquid Filled, Class 1, 1%
24033	CCL-60"	3-1/8" (80mm)	Illuminating
24065	CCLBV-60"	3-1/8" (80mm)	Liquid Filled, Class 1, 1%
24040	CCLBV-60"	3-1/8" (80mm)	Illuminating
24069	CCLS-60"	3-1/8" (80mm)	Liquid Filled, Class 1, 1%
24044	CCLS-60"	3-1/8" (80mm)	Illuminating

R410A			
PART NO.	HOSES	GAUGE SIZE	GAUGE FEATURES
24500	Manifold Only	2-1/2" (63.5mm)	R410A Only
24525	Manifold Only	3-1/8" (80mm)	R410A Only
24508	CCL-60"	2-1/2" (63.5mm)	R410A Only
24533	CCL-60"	3-1/8" (80mm)	R410A Only

R407A	R422B	R427A	
PART NO.	HOSES	GAUGE SIZE	GAUGE FEATURES
24325	Manifold Only	3-1/8" (80mm)	Illuminating

R22	R407C	410A	
PART NO.	HOSES	GAUGE SIZE	GAUGE FEATURES
24425	Manifold Only	3-1/8" (80mm)	Illuminating

Climate Class
 Digital Manifolds
 Vacuum Pumps
 Recovery
 Scales
 Digital Gauges
 Leak Detection
 Manifolds/Gauges
 Hoses
 Mini-Split Tool Kits
 SHIELD
 CoreMax
 Access Valves
 Brass Fittings
 Ball Valves
 Just Better Tools
 Capillary Tubing
 Automotive/LA-CO
 Warranty/Repair
 Index/Contacts

ZEPPELIN®

4-Valve Forged Aluminum Manifold

- Heavy-duty forged aluminum body is rugged and durable
- Rubber handwheels for improved grip and reduced effort to open/close
- Full 3/8" bore evacuates 40% faster
- Surge dampened gauges for reduced needle movement
- Available with 2-1/2", 3-1/8" and 4" gauges
- Easy-to-read, color-coded refrigerant dials
- Replaceable, durable hanging hook
- Replaceable intake/hose holder fittings
- 1 year warranty; lifetime on bar
- Made in the USA 



R22	R404A	R410A	
PART NO.	HOSES	GAUGE SIZE	GAUGE FEATURES
25200	Manifold Only	2-1/2" (63.5mm)	Standard
25250	Manifold Only	3-1/8" (80mm)	Liquid Filled, Class 1, 1%
25225	Manifold Only	3-1/8" (80mm)	Illuminating
25225L	Manifold Only	3-1/8" (80mm)	LED
25208	CCL4-60"	2-1/2" (63.5mm)	Standard
25258	CCL4-60"	3-1/8" (80mm)	Liquid Filled, Class 1, 1%
25233	CCL4-60"	3-1/8" (80mm)	Illuminating
25233L	CCL4-60"	3-1/8" (80mm)	LED
25265	CCLV4-60"	3-1/8" (80mm)	Liquid Filled, Class 1, 1%
25240	CCLV4-60"	3-1/8" (80mm)	Illuminating
25248	CCLV-60"	3-1/8" (80mm)	Illuminating
25269	CCLV4-60"	3-1/8" (80mm)	Liquid Filled, Class 1, 1%
25246	CCLS-60"	3-1/8" (80mm)	Illuminating

R22	R134A	R404A	
PART NO.	HOSES	GAUGE SIZE	GAUGE FEATURES
25100	Manifold Only	2-1/2" (63.5mm)	Standard
25150	Manifold Only	3-1/8" (80mm)	Liquid Filled, Class 1, 1%
25125	Manifold Only	3-1/8" (80mm)	Illuminating
25108	CCL4-60"	2-1/2" (63.5mm)	Standard
25158	CCL4-60"	3-1/8" (80mm)	Liquid Filled, Class 1, 1%
25133	CCL4-60"	3-1/8" (80mm)	Illuminating
25165	CCLV4-60"	3-1/8" (80mm)	Liquid Filled, Class 1, 1%
25140	CCLBV-60"	3-1/8" (80mm)	Illuminating
25169	CCLS-60"	3-1/8" (80mm)	Liquid Filled, Class 1, 1%
25144	CCLS-60"	3-1/8" (80mm)	Illuminating

R22	R134A	R404A	R410A
PART NO.	HOSES	GAUGE SIZE	GAUGE FEATURES
25708	CCL4-60"	4" (102mm)	Illuminating
25713	CCLV4-60"	4" (102mm)	Illuminating

R12	R22	R502	
PART NO.	HOSES	GAUGE SIZE	GAUGE FEATURES
25000	Manifold Only	2-1/2" (63.5mm)	Standard
25050	Manifold Only	3-1/8" (80mm)	Liquid Filled, Class 1, 1%
25025	Manifold Only	3-1/8" (80mm)	Illuminating
25008	CCL4-60"	2-1/2" (63.5mm)	Standard
25058	CCL4-60"	3-1/8" (80mm)	Liquid Filled, Class 1, 1%
25033	CCL4-60"	3-1/8" (80mm)	Illuminating
25065	CCLV4-60"	3-1/8" (80mm)	Liquid Filled, Class 1, 1%
25040	CCLV4-60"	3-1/8" (80mm)	Illuminating
25069	CCLS-60"	3-1/8" (80mm)	Liquid Filled, Class 1, 1%
25044	CCLS-60"	3-1/8" (80mm)	Illuminating

R410A			
PART NO.	HOSES	GAUGE SIZE	GAUGE FEATURES
25500	Manifold Only	2-1/2" (63.5mm)	R410A Only
25550	Manifold Only	3-1/8" (80mm)	Liquid Filled, R410A Only
25525	Manifold Only	3-1/8" (80mm)	R410A Only
25508	CCL4-60"	2-1/2" (63.5mm)	R410A Only
25558	CCL4-60"	3-1/8" (80mm)	Liquid Filled, R410 Only
25533	CCL4-60"	3-1/8" (80mm)	R410A Only
25523	CCLV4-60"	2-1/2" (63.5mm)	R410A Only
25573	CCLV4-60"	3-1/8" (80mm)	Liquid Filled, R410A Only
25548	CCLV4-60"	3-1/8" (80mm)	R410A Only

R407A	R422B	R427A	
PART NO.	HOSES	GAUGE SIZE	GAUGE FEATURES
25325	CCL4-60"	3-1/8" (80mm)	Illuminating
25608	CCL4-60"	3-1/8" (80mm)	Liquid Filled, Class 1, 1%

R22	R407C	410A	
PART NO.	HOSES	GAUGE SIZE	GAUGE FEATURES
25425	Manifold Only	3-1/8" (80mm)	Illuminating

R438A	R407C	422D	
PART NO.	HOSES	GAUGE SIZE	GAUGE FEATURES
25825	Manifold Only	3-1/8" (80mm)	Illuminating
25833	CCL4-60"	3-1/8" (80mm)	Illuminating

Additional manifold gauge options, refrigerant combinations and accessories available on page 29. Hose options available begin on page 30. Manifold rebuild kits and repair parts on page 77.

M2 Standard 2-Valve Classic Brass Manifold

- Full-flow, free-floating, dual o-ring sealing system design for faster evacuation and charging
- Forged brass bar with angled bar for increased knuckle clearance to rotate handwheels
- Heavy-duty, all-metal gauge cases for added durability
- Surge dampened gauges for reduced needle movement
- Available in 2-1/2" and 3-1/8" gauges
- Easy-to-read, color-coded refrigerant dials
- Replaceable, durable hanging hook and intake/hose holder fittings
- Easy-to-turn plastic handwheels; metal available on select models
- 1 year warranty; lifetime on bar
- Made in the USA 

Free-Floating, Dual O-Ring Sealing System

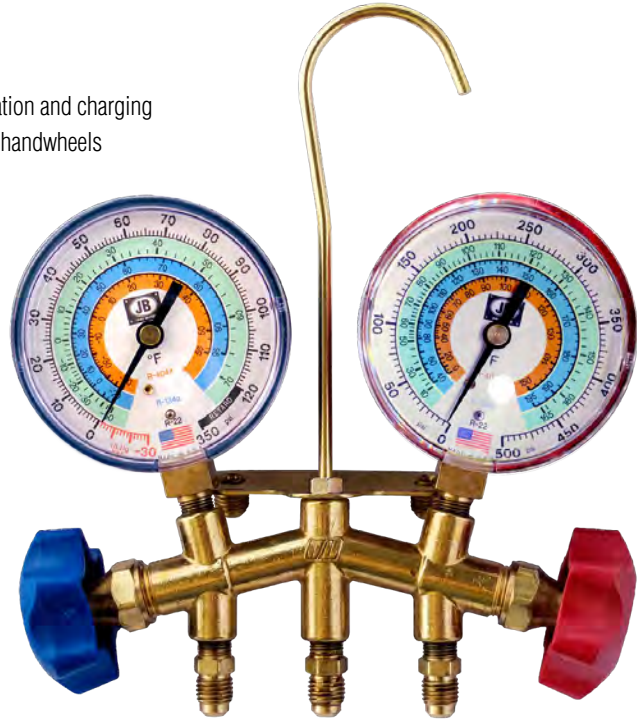
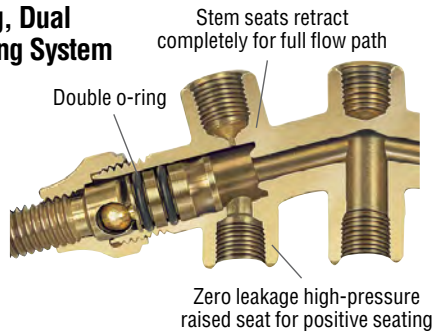

M2-23125

R22	R404A	R410A	
PART NO.	HOSES	GAUGE SIZE	GAUGE FEATURES
M2-8-410A*	Manifold Only	2-1/2" (63.5mm)	Standard
M2-8-410AB	Manifold Only	2-1/2" (63.5mm)	Standard w/boots
M2-5-410A*	CCL-60"	2-1/2" (63.5mm)	Standard
M2-5-410AB	CCL-60"	2-1/2" (63.5mm)	Standard w/boots
M2-5-410A-SS	CCLS-60"	2-1/2" (63.5mm)	Standard
M2-23225	Manifold Only	3-1/8" (80mm)	Illuminating, Class 1, 1%
M2-22225	Manifold Only	3-1/8" (80mm)	Illuminating
M2-23231	CCL-60"	3-1/8" (80mm)	Illuminating, Class 1, 1%
M2-22231	CCL-60"	3-1/8" (80mm)	Illuminating
M2-22244	CCLS-60"	3-1/8" (80mm)	Illuminating

R22	R134A	R404A	
PART NO.	HOSES	GAUGE SIZE	GAUGE FEATURES
M2-21125	Manifold Only	2-1/2" (63.5mm)	Standard
M2-21125B	Manifold Only	2-1/2" (63.5mm)	Standard w/boots
M2-21131	CCL-60"	2-1/2" (63.5mm)	Standard
M2-21131B	CCL-60"	2-1/2" (63.5mm)	Standard w/boots
M2-23125	Manifold Only	3-1/8" (80mm)	Illuminating, Class 1, 1%
M2-22125	Manifold Only	3-1/8" (80mm)	Illuminating
M2-23131	CCL-60"	3-1/8" (80mm)	Illuminating, Class 1, 1%
M2-22131	CCL-60"	3-1/8" (80mm)	Illuminating

R22	R407C	410A	
PART NO.	HOSES	GAUGE SIZE	GAUGE FEATURES
M2-22425	Manifold Only	3-1/8" (80mm)	Illuminating

R12	R22	R502	
PART NO.	HOSES	GAUGE SIZE	GAUGE FEATURES
M2-8	Manifold Only	2-1/2" (63.5mm)	Standard
M2-8B	Manifold Only	2-1/2" (63.5mm)	Standard w/boots
M2-6	CL-36R, CL-36B, CL-60Y	2-1/2" (63.5mm)	Standard
M2-6B	CL-36R, CL-36B, CL-60Y	2-1/2" (63.5mm)	Standard w/boots
M2-5	CCL-60"	2-1/2" (63.5mm)	Standard
M2-5B	CCL-60"	2-1/2" (63.5mm)	Standard w/boots
M2-36	CCL-36"	2-1/2" (63.5mm)	Standard
M2-36B	CCL-36"	2-1/2" (63.5mm)	Standard w/boots

R410A			
PART NO.	HOSES	GAUGE SIZE	GAUGE FEATURES
M2-21525	Manifold Only	2-1/2" (63.5mm)	R410A Only
M2-21525B	Manifold Only	2-1/2" (63.5mm)	R410A Only w/boots
M2-22525	Manifold Only	3-1/8" (80mm)	R410A Only
M2-21531	CCL-60"	2-1/2" (63.5mm)	R410A Only
M2-21531B	CCL-60"	2-1/2" (63.5mm)	R410A Only w/boots
M2-22531	CCL-60"	3-1/8" (80mm)	R410A Only

R407A	R422B	R427A	
PART NO.	HOSES	GAUGE SIZE	GAUGE FEATURES
M2-22325	Manifold Only	3-1/8" (80mm)	Illuminating

M089	R407C	422D	
PART NO.	HOSES	GAUGE SIZE	GAUGE FEATURES
M2-22825	Manifold Only	3-1/8" (80mm)	Illuminating
M2-22831	CCL-60"	3-1/8" (80mm)	Illuminating

Additional manifold gauge options, refrigerant combinations and accessories available on page 29. Hose options available begin on page 30. Manifold rebuild kits and repair parts on page 77.

M2 Heat Pump Manifold 2-Valve Forged Brass Body

- Full-flow, free-floating, dual o-ring sealing system design for faster evacuation and charging
- Includes Illuminating, Class 1, 1% metal gauges designed for 800psi to handle heat pump pressures
- Pressure/temperature scale has two sections to accommodate temperature glide on R407c
- Replaceable, durable hanging hook and intake/hose holder fittings
- 1 year warranty; lifetime on bar
- Made in the USA 



M2-HP

CO₂ Manifold 2-Valve Aluminum Manifold

- For transcritical CO₂ applications
- Unique spindle valves tighten easily
- 3-1/8" (80mm) Class 1, 1% pulse-free liquid filled gauges
- 36" hoses with 1/4" SAE fittings (3 pack)
- Working pressure 2900 psi (200 bar)
- 3 year warranty

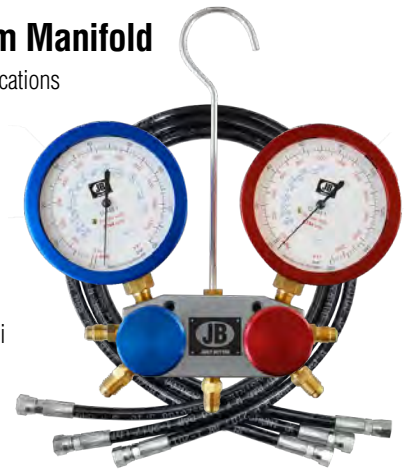

Specifications

Low Pressure	30" of Hg to 1200 psi (83 bar)
High Pressure	30" of Hg to 2300 psi (160 bar)
Temperature Range	-60°F to 80°F (-55°C to 30°C)
Critical Point	87.98°F/1.071 psi (31.1°C/72.9 bar)
Certifications	EN472/EN837 Pressure Equipment Directive and 2014/68/CE Article 4, Paragraph 3



R22	R407C	410A
-----	-------	------

PART NO.	HOSES	GAUGE SIZE	GAUGE FEATURES
M2-HP	Manifold Only	3-1/8" (80mm)	Illuminating, Class 1, 1%
M2-HP-5	CL6-60" (3)	3-1/8" (80mm)	Illuminating, Class 1, 1%
M2-808	Replacement Gauge	3-1/8" (80mm)	Illuminating, Class 1, 1%

PART NO.	DESCRIPTION
30744	CO ₂ Manifold with 36" hose set in protective carrying case
CL744-36	36" single hose for CO ₂ manifold

Metric Manifolds

Metric manifolds come with 63.5 mm (2-1/2") metric gauges in BAR/PSI, kPa/PSI and kg/cm², as well as standard CL and KOBRA® CLE series hoses. Refer to the M2 Brass, 2-Valve Aluminum ZEPPELIN® and 4-Valve ZEPPELIN® pages for a full list of features for each. Also available with 80mm (3-1/8") metric gauges in select quantities. For more information, contact customer service. Made in the USA 

DESCRIPTION	M2 BRASS			2-VALVE ZEPPELIN®			4-VALVE ZEPPELIN®			REFRIGERANTS		
	BAR/PSI	kPa/PSI	Kg/cm ²	BAR/PSI	kPa/PSI	Kg/cm ²	BAR/PSI	kPa/PSI	Kg/cm ²	R22	R404A	R410A
Manifold Only	28592	28292	28192	28752	28852	28952	27752	27852	27952	•	•	•
CCL-60" (152cm)	28596	28296	28196	28754	28854	28954	27754	27854	27954	•	•	•
CCLS5-60 (152cm)	28597	28297	28197	—	—	—	—	—	—	•	•	•
CCLBV KOBRA®	28599	28299	28199	28759	28859	28959	27759	27859	27959	•	•	•
DESCRIPTION	M2 BRASS			2-VALVE ZEPPELIN®			4-VALVE ZEPPELIN®			REFRIGERANTS		
	BAR/PSI	kPa/PSI	Kg/cm ²	BAR/PSI	kPa/PSI	Kg/cm ²	BAR/PSI	kPa/PSI	Kg/cm ²	R12	R22	R502
Manifold Only	28572	28272	28172	28772	28872	28972	27772	27872	27972	•	•	•
CCL-36" (91cm)	28570	28270	28170	28770	28870	28970	27770	27870	27970	•	•	•
CCL-60" (152cm)	28574	28274	28174	28774	28874	28974	27774	27874	27974	•	•	•
CCLS-60" (152cm) UL R410A	28576	28276	28176	28776	28876	28876	27776	27774	27776	•	•	•
DESCRIPTION	M2 BRASS			2-VALVE ZEPPELIN®			4-VALVE ZEPPELIN®			REFRIGERANTS		
	BAR/PSI	kPa/PSI	Kg/cm ²	BAR/PSI	kPa/PSI	Kg/cm ²	BAR/PSI	kPa/PSI	Kg/cm ²	R134A	R404A	R507A
Manifold Only	28582	28282	28182	28782	28882	28982	27782	27882	27982	•	•	•
CCL-36" (91cm)	28580	28280	28180	28780	28880	28980	27780	27880	27980	•	•	•
CCL-60" (152cm)	28584	28284	28184	28784	28884	28984	27784	27884	27984	•	•	•
CCL-60" (152cm)	28586	28286	28186	28786	28886	28986	27786	27886	27986	•	•	•
CCLS-60" (152 cm) UL R410A	28588	28288	28188	28788	28888	28988	27788	27888	27988	•	•	•
DESCRIPTION	M2 BRASS			2-VALVE ZEPPELIN®			4-VALVE ZEPPELIN®			REFRIG.		
	BAR/PSI	kPa/PSI	Kg/cm ²	BAR/PSI	kPa/PSI	Kg/cm ²	BAR/PSI	kPa/PSI	Kg/cm ²	R134A		
Manifold Only	28502	28202	28102	28732	28832	28932	—	—	—	•		
CCL-36" (91 cm)	28505	28205	28105	28735	28835	28935	—	—	—	•		

Gauges

LED Gauges

- 3-1/8" Metal gauges for use with R22, R404A and R410A
- On/off rocker switch; 250+ hour battery life
- 3v Lithium coin cell battery (included)
- Available in convenient 8-pack counter display as **M2-LED8PK**
- Made in the USA 



PART NO.	DESCRIPTION
M2-820L	3-1/8" Compound, LED
M2-825L	3-1/8" Pressure, LED
M2-LED8PK	8 pack LED counter display

A2L/ Hydrocarbon Gas Gauges

NEW

- Flammable gas gauges for hydrocarbon refrigerants
- 3-1/8" Illuminating, Class 1, 1% metal gauges with high impact clear view Lexan lens
- Full-size brass movements
- See page 22 for PATRIOT manifold pairings
- Made in the USA 



REFRIGERANT COMBINATIONS IN CHART P. 29	
COMPOUND	PRESSURE
M2-600	M2-605
M2-861	M2-862
M2-871	M2-872
M2-472	M2-473
M2-876	M2-877

Gauge Options



M2-820
3-1/8" Illuminating,
Standard



M2-810 (R410A Only)
3-1/8" Non-illuminating,
Standard



M2-860
3-1/8" Liquid Filled,
Class 1, 1%



M2-924CM
3-1/8" Illuminating,
Class 1, 1%

Gauge Boots/Lenses

- Protective gauge boots add increased durability to manifold gauges
- Available for 2-1/2" and 3-1/8" gauges
- Made in the USA 



MR-596



MR-533

PART NO.	DESCRIPTION
MR-590	2-1/2" Black boot (single)
MR-593	3-1/8" Black boot (single)
MR-594	3-1/8" Red boot for M2-865 liquid filled (single)
MR-595	3-1/8" Blue boot for M2-860 liquid filled (single)
MR-596	Set of two 3-1/8" black boots
MR-596L	Set of two 3-1/8" black boots for LED gauges
MR-598	Set of two black 2-1/2" black boots
MR-517	2-1/2" Screw-on lens fits both plastic and metal gauges
MR-533	3-1/8" Snap-on lens

Gas Pressure Test Kits

- Made in the USA 



PART NO.	DESCRIPTION
29433	Natural and LP gas; Scale 0-20 oz/sq. in; 0-15" of water column
29435	Natural and LP gas; Scale 0-20 oz/sq. in; 0-30" of water column
29436	Natural gas only; Scale 0-6 oz/sq. in; 0-10" of water column



M2-460
2-1/2" Non-illuminating,
Standard



M2-400
4" Illuminating,
Class 1, 1%

Gas Test Bell Gauges

- Made in the USA 



PART NO.	DESCRIPTION
GTBG-12	3-1/2" Test gauge 0-30lb 3/4" end
GTBG-16	3-1/2" Test gauge 0-30lb 1" end



QC-G430
2-1/2" Single Test,
Standard



QC-G851
3-1/8" Single Test,
Standard

Gauge Options

All-metal gauges with high impact clear view Lexan lens, full-size brass movements and recalibrating screw. Available for compound and pressure in assorted sizes and options for use, visibility and refrigerant type. Metric gauges and replacement lenses also available; contact customer service. Made in the USA 

PART NO.	SIZE	DESCRIPTION	REFRIGERANTS																				
			COMPOUND	PRESSURE	R12	1234YF	R22	R32	R134A	R438A	R290	R404A	R407A	R407C	R410A	R422B	R427A	R448A	R449A	R454B	R502	R507A	R600A
M2-861	M2-862	3-1/8" (80mm)	Illuminating, Class 1, 1%				•							•					•				
M2-871	M2-872	3-1/8" (80mm)	Illuminating, Class 1, 1%															•	•				
M2-472	M2-473	3-1/8" (80mm)	Illuminating, Class 1, 1%		•			•															
M2-876	M2-877	2-1/2" (63.5mm)	Illuminating, Class 1, 1%											•			•	•					
M2-250	M2-500	2-1/2" (63.5mm)	Non-illuminating, Standard	•		•														•			
M2-350	M2-355	2-1/2" (63.5mm)	Non-illuminating, Standard					•															
M2-400	M2-405	4" (102mm)	Illuminating, Class 1, 1%			•		•			•			•									
M2-410	M2-415	2-1/2" (63.5mm)	Non-illuminating, Standard											•									
M2-420	M2-425	2-1/2" (63.5mm)	Non-illuminating, Standard					•			•											•	
M2-430	M2-435	2-1/2" (63.5mm)	Non-illuminating, Standard			•		•			•												
M2-460	M2-465	2-1/2" (63.5mm)	Non-illuminating, Standard			•					•			•									
M2-600	M2-605	3-1/8" (80mm)	Illuminating, Class 1, 1%					•		•													•
M2-800	M2-805	3-1/8" (80mm)	Illuminating, Standard	•		•														•			
M2-810	M2-815	3-1/8" (80mm)	Non-illuminating, Standard											•									
M2-820	M2-825	3-1/8" (80mm)	Illuminating, Standard			•					•			•									
M2-820L	M2-825L	3-1/8" (80mm)	LED, Standard			•					•			•									
M2-826	M2-827	3-1/8" (80mm)	Illuminating, Standard			•		•						•									
M2-828	M2-829	3-1/8" (80mm)	Illuminating, Standard									•			•	•							
M2-830	M2-831	3-1/8" (80mm)	Illuminating, Standard			•							•	•									
M2-844	M2-845	3-1/8" (80mm)	Illuminating, Standard						•				•		•								
M2-851	M2-856	3-1/8" (80mm)	Illuminating, Standard			•		•			•												
M2-860	M2-865	3-1/8" (80mm)	Liquid Filled, Class 1, 1%			•		•			•			•									
M2-870	M2-875	3-1/8" (80mm)	Liquid Filled, Class 1, 1%	•		•														•			
M2-880	M2-885	3-1/8" (80mm)	Liquid Filled, Class 1, 1%			•		•			•												
M2-890	M2-895	3-1/8" (80mm)	Liquid Filled, Class 1, 1%			•					•			•									
M2-924	M2-925	3-1/8" (80mm)	Illuminating, Class 1, 1%			•					•			•									
M2-924CM	M2-925CM	3-1/8" (80mm)	Illuminating, Class 1, 1%, Camo			•					•			•									
M2-951	M2-956	3-1/8" (80mm)	Illuminating, Class 1, 1%			•		•			•												
QC-G430	QC-G434	2-1/2" (63.5mm)	Single Test, Standard			•		•			•												
QC-G460	QC-G465	2-1/2" (63.5mm)	Single Test, Standard			•					•			•									
QC-G820	QC-G825	3-1/8" (80mm)	Single Test, Standard			•					•			•									
QC-G851	QC-G856	3-1/8" (80mm)	Single Test, Standard			•		•			•												

Gauges indicated as Standard are accuracy rated 3-2-3%
 Note: Gauges and hoses not specified for use with R410A can damage tool and cause injury.

Metric Gauges

COMPOUND			REFRIGERANTS						
BAR/PSI	K/PSI	KG/CM ²	R12	R22	R134A	R404A	R410A	R502	R507A
29310	29311	29312		•		•	•		
29333	---	---		•	•	•			
29290	---	29292			•	•			•
29280	29260	29384	•	•				•	
29330	29331	29332			•				

PRESSURE			REFRIGERANTS						
BAR/PSI	K/PSI	KG/CM ²	R12	R22	R134A	R404A	R410A	R502	R507A
29315	29316	29317		•		•	•		
29338	---	---		•	•	•			
29295	---	29297			•	•			•
29285	29263	29385	•	•				•	
29335	29336	29337			•				

Cirrate Class
 Digital Manifolds
 Vacuum Pumps
 Recovery
 Scales
 Digital Gauges
 Leak Detection
 Manifolds/Gauges
 Hoses
 Mini-Split Tool Kits
 SHIELD
 CoreMax
 Access Valves
 Brass Fittings
 Ball Valves
 Just Better Tools
 Capillary Tubing
 Automotive/LA-CO
 Warranty/Repair
 Index/Contacts

CNTL90 Series

NEW

2mm Pressure Control Hose

Pressure control hose is constructed of an inner core of polyamide and an outer cover of vinyl. The polyamide inner core is wrapped with a synthetic fiber to give the hose pull strength. The polyamide inner lining is the reason it can withstand higher pressures and eliminates the vibration failures of copper capillary tube installations. Higher temperature ratings up to 266°F eliminate the failures caused by maximum loads on rubber hoses.

- Highly flexible; extremely short bending radius; 2mm ID
- Suitable for all non-corrosive refrigerants including flammable gases, HFC, HFO, HC and CO2 sub-critical refrigerants and the relevant special oils such as ester- and PAG
- 90° x Straight, 1/4" FFL Connects
- Absorbs all possible multidirectional vibrations
- 1000 psi working; 5000 psi burst
- Temp Range -40°(-40°C) to 266°(130°C)
- Ozone-, UV- and oil resistant



CNTL90 SERIES

CNTL90 SERIES 1/4" X 1/4" 2MM PRESSURE CONTROL HOSE (PSI 1160/14,500)		
PART NO.	LENGTH	COLOR
CNTL90-12	12" (30cm)	Black
CNTL90-18	18" (46cm)	Black
CNTL90-24	24" (61cm)	Black
CNTL90-30	30" (76cm)	Black
CNTL90-36	36" (91cm)	Black
CNTL90-48	48" (122cm)	Black
CNTL90-60	60" (152cm)	Black

CLRF Series

NEW

2mm Polyamide Capillary Flexible Vibration Eliminating Hydrocarbon Hose

The sophisticated CLRF Series hose system is a safe and cost effective polyamide capillary hose for use with critical charge hydrocarbon refrigeration systems. CLRF Series hose has excellent mechanical and thermal properties combined with extreme durability and vibration eliminating performance.

- Highly flexible; extremely short bending radius; 2mm ID
- Suitable for all non-corrosive refrigerants including flammable gases, HFC, HFO, HC and CO2 sub-critical refrigerants and the relevant special oils such as ester- and PAG
- Absorbs all possible multidirectional vibrations
- Maximum working pressure 1160 psi (80 bar)
- Very high burst proof value > 14,500 psi (1,000 bar)
- Temp Range -40°(-40°C) to 266°(130°C)
- Ozone-, UV- and oil resistant



Available individually or with the PATRIOT™ 2-valve brass manifold

CLRF SERIES

CLRF SERIES 1/4" X 1/4" FLEXIBLE HYDROCARBON HOSE (PSI 1160/14,500)				
LENGTH	BLUE	YELLOW	RED	B/Y/R 3 PACK
18" (46cm)	CLRF-18B	CLRF-18Y	CLRF-18R	CCLRF-18
22733RF-18	2-Valve PATRIOT™ w/R290/R600/R32 illuminating gauges and 18" CLRF Series Hose Set			

CLSX Series

KOBRA® Secure Seal Hose

- 800 psi working; 4000 psi burst
- Larger fitting for increased flow
- UL approved for R410A
- Removable head and rebuildable seal kit for quick, easy field repair or replacement
- Angled depressor with custom gasket and large fitting to prevent leaks and increase flow
- Dual thrust washers (Teflon and stainless steel) for easy turn and free rotation under high pressure
- Smooth action, low-loss fitting minimizes refrigerant loss and prevents spray
- Made in the USA 

NEW



CLSX SERIES KOBRA® 1/4" X 1/4" SECURE SEAL (PSI 800/4000)				
LENGTH	BLUE	YELLOW	RED	B/Y/R 3 PACK
36" (91cm)	CLSX-36B	CLSX-36Y	CLSX-36R	CCLSX-36
48" (122cm)	CLSX-48B	CLSX-48Y	CLSX-48R	CCLSX-48
60" (152cm)	CLSX-60B	CLSX-60Y	CLSX-60R	CCLSX-60
72" (182cm)	CLSX-72B	CLSX-72Y	CLSX-72R	CCLSX-72
Replaceable Head		CLSX-RH		
Rebuild Kit		CLSX-RK		

CLSX Series Repair Instructions

Easily Replace/Repair Head with Basic Tools

Replace Head CLSX-RH

1. Attach 3/8" wrench to the flats of the head base. Use an adjustable wrench on hex of the barb and turn counterclockwise to remove the head. Apply one to two drops of a standard thread sealant or Teflon tape to the pipe thread of the hose barb.
2. Attach new head and finger tighten turning clockwise. Use 3/8" wrench and adjustable wrench to fully tighten. Torque to 6ft/lbs (approximately 3/4 to 1-1/2 turns past finger tight).



Rebuild Head CLSX-RK

1. Attach 3/8" wrench to the flats of the head base. Use an adjustable wrench on hex of the barb and turn counterclockwise to remove the head.
2. Use spring clip pliers to remove internal spring clip from inside of end cap assembly. Remove coupler nut exposing cup assembly.
3. Remove the metal and nylon thrust washers.
4. Stabilize slot at base of cup assembly with straight-edge and using a 3/8" wrench turn counterclockwise to detach end cap from cup assembly. Remove and replace end cap o-ring.
5. Remove and discard spring, depressor, and gasket from inside cup using pointed hook or removal tool.
6. Remove and replace o-ring from slotted end of cup.
7. Insert new gasket, depressor and spring in cup. Apply one to two drops of a standard thread sealant or Teflon tape to the pipe thread of the end cap. Reattach end cap with new o-ring to cup assembly using a 3/8" wrench and a straight edge.
8. Replace the metal and nylon thrust washers. Place cup assembly into coupler nut.
9. Use spring clip pliers to secure internal snap ring inside of end cap assembly. Refer to REPLACE HEAD Step 1 and 2 to reassemble.

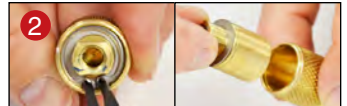

CLS Series

KOBRA® Secure Seal Hose

- 800 psi working; 4000 psi burst
- UL R410A approved Secure Seal, specially designed to lock refrigerant inside the hose without the need for a ball valve attachment
- Fully field repairable with **33112RK/33115RK Rebuild Kits**
- Stainless steel thrust washer ensures free rotation under high pressure
- Three-point contact on depressor
- Made in the USA 



CLS SERIES KOBRA® 1/4" X 1/4" SECURE SEAL HOSE (PSI 800/4000)					
LENGTH	BLUE	YELLOW	RED	B/Y/R 3 PACK	B/Y/R BLACK: 3/8" 4 PACK
36" (91cm)	CLS-36B	CLS-36Y	CLS-36R	CCLS-36	CCLS4-36
48" (122cm)	CLS-48B	CLS-48Y	CLS-48R	CCLS-48	CCLS4-48
60" (152cm)	CLS-60B	CLS-60Y	CLS-60R	CCLS-60	CCLS4-60
72" (182cm)	CLS-72B	CLS-72Y	CLS-72R	CCLS-72	CCLS4-72
10' (3m)	CLS-120B	CLS-120Y	CLS-120R		
25' (7.6m)	CLS-300B	CLS-300Y	CLS-300R		
50' (15.2m)	CLS-600B	CLS-600Y	CLS-600R		
75' (22.8m)	CLS-900B	CLS-900Y	CLS-900R		
100' (30.5m)	CLS-1200B	CLS-1200Y	CLS-1200R		
CLS5 SERIES KOBRA® 1/4" X 5/16" SECURE SEAL HOSE* (PSI 800/4000)					
36" (91cm)	CLS5-36B	CLS5-36Y	CLS5-36R	CCLS5-36	
48" (122cm)	CLS5-48B	CLS5-48Y	CLS5-48R	CCLS5-48	
60" (152cm)	CLS5-60B	CLS5-60Y	CLS5-60R	CCLS5-60	
72" (182cm)	CLS5-72B	CLS5-72Y	CLS5-72R	CCLS5-72	

*B/Y/R 3 pack for CLS5 Series includes 5/16" blue and red hose with 1/4" yellow hose.

CLS Series Repair Instructions

For use with 33112RK/33115RK Rebuild Kits

1. Hold the cup in one hand so that the slotted face of the cup is exposed. Pinch the cup seal o-ring and insert it into the large groove to seat it correctly as shown.
2. Install the barb seal o-ring in the groove located between the hex feature and the back portion of thread. Gently stretch and pull it over the threads of the barb fitting. Ensure the seal is not torn or damaged.
3. Insert bushing/seal into the thread side of the cup. Brass bushing side goes in first with seal facing up as shown.
4. Insert depressor with three-blade feature into the cup assembly. The depressor fits into the bushing/seal installed in the previous step. The depressor must sit flat and true to the seal surface.
5. Place spring into cup assembly over the emboss on the back of the depressor.
6. Screw cup assembly, with spring in an upward position, onto hose barb fitting. Hand tighten the cup to the barb ensuring cup seats over the barb gasket (o-ring) and does not damage the o-ring.
7. Tighten the cup and hose barb using a 9/16" open-end wrench and 1/16" steel blade. Do not over tighten—only 25 to 30 in/lbs is required.
8. Insert barb/cup assembly into the coupler. Seat the thrust washer flat onto the hose barb and inside the coupler. Install the internal snap ring and seat it into the groove of the coupler.

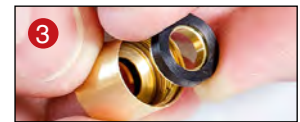
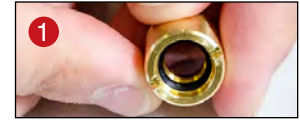

For additional information on assembly or disassembly, refer to 33112RK or 33115RK Rebuild Kit Instructions online at JBIND.COM.

CLE Series

KOBRA® Gasket Seal Hose

- 800 psi working; 4000 psi burst
- Gasket seal, high-pressure charging hose
- Blow-out resistant gasket locks into the cup of the fitting
- Barbed depressor precisely machined to guide the valve core into place
- Easy grip 14 TPI pitch knurl
- Made in the USA 



CLE SERIES



CLE SERIES KOBRA® 1/4" X 1/4" GASKET SEAL HOSE (PSI 800/4000)					
LENGTH	BLUE	YELLOW	RED	B/Y/R 3 PACK	B/Y/R BLACK: 3/8" 4 PACK
36" (91cm)	CLE-36B	CLE-36Y	CLE-36R	CCLC-36	CCLC4-36
48" (122cm)	CLE-48B	CLE-48Y	CLE-48R	CCLC-48	CCLC4-48
60" (152cm)	CLE-60B	CLE-60Y	CLE-60R	CCLC-60	CCLC4-60
72" (182cm)	CLE-72B	CLE-72Y	CLE-72R	CCLC-72	CCLC4-72
10' (3m)	CLE-120B	CLE-120Y	CLE-120R		
25' (7.6m)	CLE-300B	CLE-300Y	CLE-300R		
50' (15.2m)	CLE-600B	CLE-600Y	CLE-600R		
75' (22.8m)	CLE-900B	CLE-900Y	CLE-900R		
100' (30.5m)	CLE-1200B	CLE-1200Y	CLE-1200R		

CLE5 SERIES KOBRA® 1/4" X 5/16" GASKET SEAL HOSE PSI 800/4000					
LENGTH	BLUE 1/4" x 5/16"	YELLOW 1/4" x 5/16"	RED 1/4" x 5/16"	BLUE/RED: 1/4" x 5/16" YELLOW: 1/4" x 1/4" 3 PACK	B/Y/R 5/16" x 5/16"
36" (91cm)	CLE5-36B	CLE5-36Y	CLE5-36R	CCLC5-36	CCLC55-36
60" (152cm)	CLE5-60B	CLE5-60Y	CLE5-60R	CCLC5-60	CCLC55-60
72" (182cm)	CLE5-72B	CLE5-72Y	CLE5-72R	CCLC5-72	CCLC55-72

CLBV Series

KOBRA® Gasket Seal Quarter-Turn Ball Valve Hose

- 800 psi working; 4000 psi burst
- Meets non-venting requirements by trapping refrigerant with ball valve
- 1/4 turn lever-style ball valve fitting at one end opens to full flow
- Barbed depressor locks into the gasket exerting more outward force pushing the gasket further into place
- Depressor is precisely machined for maximum flow and has a dimple that guides the valve core into place
- Made in the USA 



CLBV SERIES



CLBV SERIES KOBRA® 1/4" X 1/4" WITH BALL VALVE (PSI 800/4000)					
LENGTH	BLUE	YELLOW	RED	B/Y/R 3 PACK	B/Y/R BLACK: 3/8" 4 PACK
36" (91cm)	CLBV-36B	CLBV-36Y	CLBV-36R	CCLBV-36	CCLBV4-36
48" (122cm)	CLBV-48B	CLBV-48Y	CLBV-48R	CCLBV-48	CCLBV4-48
60" (152cm)	CLBV-60B	CLBV-60Y	CLBV-60R	CCLBV-60	CCLBV4-60
72" (182cm)	CLBV-72B	CLBV-72Y	CLBV-72R	CCLBV-72	CCLBV4-72

CCLBV5 SERIES KOBRA® 1/4" X 5/16" WITH BALL VALVE (PSI 800/4000)	
LENGTH	BLUE/RED: 1/4" x 5/16" YELLOW: 1/4" x 1/4" 3 PACK
36" (91cm)	CCLBV5-36
60" (152cm)	CCLBV5-60
72" (182cm)	CCLBV5-72

CLV Series

KOBRA® Gasket Seal Quarter-Turn Ball Valve Hose with 6" Whip End

- 800 psi working; 4000 psi burst
- Meets non-venting requirements by trapping refrigerant with ball valve
- **CLV6:** 6" Ball valve with whip end
- **CLP:** 6" Whip end only
- Made in the USA 



CLV SERIES

CLV SERIES KOBRA® 1/4" X 1/4" W/BALL VALVE WHIP END (PSI 800/4000)					
LENGTH	BLUE	YELLOW	RED	B/Y/R 3 PACK	B/Y/R BLACK (3/8") 4 PACK
36" (91cm)	CLV-36B	CLV-36Y	CLV-36R	CCLV-36	CCLV4-36
48" (122cm)	CLV-48B	CLV-48Y	CLV-48R	CCLV-48	CCLV4-48
60" (152cm)	CLV-60B	CLV-60Y	CLV-60R	CCLV-60	CCLV4-60
72" (182cm)	CLV-72B	CLV-72Y	CLV-72R	CCLV-72	CCLV4-72
CLV SERIES W/BALL VALVE WHIP END ONLY (PSI 800/4000)					
1/4" x 6"	CLV-6B	CLV-6Y	CLV-6R	CCLV-6	CLV-6BL
3/8" x 6"		CLV6-6Y			CLV6-6BL
CLP SERIES KOBRA® 1/4" X 1/4" HOSE WHIP END ONLY (PSI 800/4000)					
6" (15cm)	CLP-6B	CLP-6Y	CLP-6R		
CLV6 AND CL6 SERIES KOBRA® 3/8" X 3/8" CHARGING HOSE (PSI 600/3000)					
LENGTH	BLACK	BLACK W/BALL VALVE	YELLOW		
36" (91cm)	CL6-36	CLV6-36	CL6-36Y		
48" (122cm)	CL6-48	CLV6-48	CL6-48Y		
60" (152cm)	CL6-60	CLV6-60	CL6-60Y		
72" (182cm)	CL6-72	CLV6-72	CL6-72Y		
CLV5 AND CCLV5 SERIES KOBRA® W/BALL VALVE WHIP END 1/4" X 5/16" (PSI 800/4000)					
LENGTH	BLUE/RED: 1/4" x 5/16" YELLOW: 1/4" x 1/4"	BLUE 1/4" x 5/16"	YELLOW 1/4" x 5/16"	RED 1/4" x 5/16"	
36" (91cm)	CCLV5-36				
60" (152cm)	CCLV5-60	CLV5-60B	CLV5-60Y	CLV5-60R	
72" (182cm)	CCLV5-72				

Heavy-Duty Series

1/4", 3/8" and 1/2" Heavy-Duty Black Charging Hose

- **1/4":** 800 psi working; 4000 psi burst
- **3/8":** 800 psi working; 4000 psi burst
- **1/2":** 640 psi working; 3200 psi burst
- Heavy-duty charging hose reduces permeation
- Straight fittings by straight fittings
- Made in the USA 



HEAVY-DUTY SERIES



HEAVY-DUTY BLACK CHARGING (PSI 1/4", 3/8" 800/4000, 1/2" 640/3200)			
LENGTH	BLACK (1/4" X 1/4")	BLACK (3/8" X 3/8")	BLACK (1/2" X 1/2")
36" (91cm)	CL4HD-36	CL6HD-36	CL2HD-36
48" (122cm)	CL4HD-48	CL6HD-48	CL2HD-48
60" (152cm)	CL4HD-60	CL6HD-60	CL2HD-60
72" (182cm)	CL4HD-72	CL6HD-72	CL2HD-72
HEAVY-DUTY BLACK EVACUATION/CHARGING HOSE (PSI 800/4000)			
LENGTH	BLACK (3/8")	BLACK (1/2")	
60" (152cm)	CL64-60 (1/4" x 3/8" fitting)	CL84-60 (1/4" x 1/2" fitting)	

Standard Series

1/4" Standard Charging Hose

- 750 psi working; 3000 psi burst
- Ideal for use with all standard refrigerants (except high pressure)
- Permeation can be detected and will vary with refrigerant type and time of exposure
- Made in the USA 



STANDARD SERIES

STANDARD 1/4" X 1/4" CHARGING HOSE (PSI 750/3000)				
LENGTH	BLUE	YELLOW	RED	B/Y/R 3 PACK
36" (91cm)	CL-36B	CL-36Y	CL-36R	CCL-36
48" (122cm)	CL-48B	CL-48Y	CL-48R	CCL-48
60" (152cm)	CL-60B	CL-60Y	CL-60R	CCL-60
72" (182cm)	CL-72B	CL-72Y	CL-72R	CCL-72

Hose Replacement Parts

- Made in the USA 



PART NO.	DESCRIPTION
A10974	O-ring/Gasket Removal Tool NEW
33112RK	1/4" Secure Seal Rebuild Kit
33115RK	5/16" Secure Seal Rebuild Kit
CLSXRK	CLSX Secure Seal Rebuild Kit
CLSXRH	CLSX Replacement Head
T21295	Snap Ring Pliers for CLS Secure Seal Fittings, Includes 33112RK 1/4" Rebuild Kit
P90022	O-ring for T21295 and 33112RK (10 pack)
P511	Gasket for 1/4" CLE, CLV, CLBV Series Hose (6 pack)
P90514	1/4" Depressor for CLE, CLV and CLBV Series (5 pack) used with P509
P90016	Gasket for 3/8" Hose (10 pack)
P90008	Gasket for 1/2" Heavy-duty Black Charging Hose (5 pack)

Permeation

Even with the advanced technology of today's hoses permeation through the hose compound still exists.

Only the finest materials available are used to manufacture JB hoses to ensure a minimum amount of permeation of the refrigerant through the hose. KOBRA® hoses are designed as transfer lines for all refrigerants (except ammonia), nitrogen and refrigerant oils.

When checking pressure-rise the atmosphere will permeate to the lower pressure in the hoses and the micron reading will slowly rise.

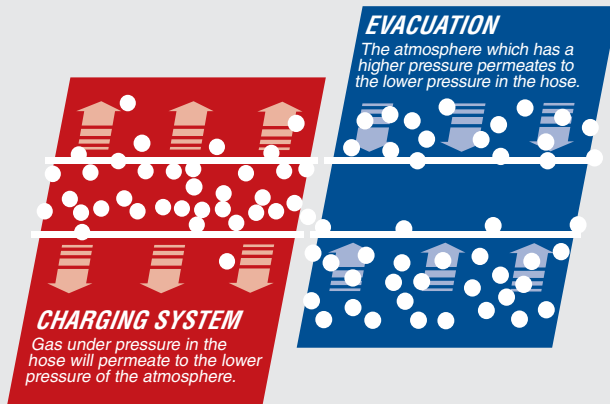

Mini Ball Valves

- 1/4" for use up to 4000 psi (276 bar) minimum burst; 800 psi (55 bar) maximum working pressure
- 5/16" for R410A applications; 4000 psi (276 bar) minimum burst; 800 psi (55 bar) maximum working pressure
- Made in the USA 



MBV4-01

PART NO.	DESCRIPTION
MBV4-03	1/4" Compact mini ball valve set (3 pack)
MBV4-01	1/4" Compact mini ball valve
MBV5-03	5/16" QC x 1/4" SAE compact mini ball valve set (3 pack)
MBV5-01	5/16" QC x 1/4" SAE compact mini ball valve
P511	Replacement Gasket

Flexible Metal Hose

- 900 psi working; 3500 psi burst
- Unlike charging hoses, flexible metal lines will not permeate under vacuum
- Metal lines feature finger-tight o-ring coupler ends
- Made in the USA 



D10472

PART NO.	DESCRIPTION
D10436	1/4" x 36" Flexible metal line (one 45° fitting)
D10472	1/4" x 72" Flexible metal line (one 45° fitting)
D10636	3/8" x 36" Flexible metal line (one 45° fitting)
D10660	3/8" x 60" Flexible metal line (one 45° fitting)
DV-294	1/4" x 10" Flexible metal line (one 45° fitting)
P90009	1/4" Replacement o-ring (10 pack)
P90012	3/8" Replacement o-ring (10 pack)

Secure Seal Adapters

- Convert your CLE Series hose into CLS Secure Seal
- Made in the USA 



33112N

33113N

PART NO.	DESCRIPTION
33112N	1/4" QC x 1/4" SAE
33113N	1/4" QC x 1/4" SAE 90°
33115N	5/16" QC x 1/4" SAE
33116N	5/16" QC x 1/4" SAE 90°

Mini-Split Tool Kits

JB INDUSTRIES

Mini-Split Tool Kits

MSKIT1 and MSKIT2

Everything you need for R410A ductless mini-splits in one convenient kit. MSKIT1 and MSKIT2 contain all essential tools to get the job done, including the award-winning PATRIOT™ 2-Valve Manifold, a KOBRA® Secure Seal hose set that is UL approved for R410A, and a heavy-duty six spanner head torque wrench.

MSKIT3

The MSKIT3 is an affordable solution for service technicians who already have a few basic tools in their toolbox.

The Manifold that Gives Back



For each PATRIOT™, MSKIT1 or MSKIT2 sold JB will donate to Operation Homefront. To learn more about Operation Homefront visit www.operationhomefront.net

NEW

Updated Manifold Gauge Refrigerants R410A/R32/R454B



MSKIT1 and MSKIT2



MSKIT 3

MSKIT1 (1/4") AND MSKIT2 (5/16") BACKPACK		
MSKIT1 INCLUDES	MSKIT2 INCLUDES	DESCRIPTION
22600	22605	PATRIOT™ manifold with R410A/R32/R454B gauges NEW
CCLS-60	CCLS5-60	KOBRA® UL approved Secure Seal hose set
A32525N	A32535N	Valve core remover w/side port
SHLD-P4	SHLD-E4	SHIELD® locking cap R410A (4 pack)
A31656	A31665	SAE brass adapters (2 included)
NFT5-4	NFT5-5	Brass caps (NFT5-4, 10 pack/NFT5-5, 5 pack)
T30605		Metric (2-8mm) and Imperial (5/64" - 1/4") hex key set
T30600		Ratcheting eccentric cone flare tool
T30600-G		Metal Flare Size Gauge; 1/4", 3/8", 1/2", 5/8", 3/4" SAE (6.4mm, 9.5mm, 12.7mm, 15.9mm, 19.1mm) NEW
TRQ1080		Torque wrench set with 6 spanner heads
JB-BACKPACK1		JB backpack (40 pockets)

MSKIT3 TOOLBAG (1/4" AND 5/16")	
MSKIT3 INCLUDES	DESCRIPTION
JB-TOOLBAG1	JB tool bag (30 pockets)
T30605	Metric (2-8mm) and Imperial (5/64" - 1/4") hex key set
T30600	Ratcheting eccentric cone flare tool
T30600-G	Metal Flare Size Gauge; 1/4", 3/8", 1/2", 5/8", 3/4" SAE (6.4mm, 9.5mm, 12.7mm, 15.9mm, 19.1mm) NEW
TRQ1080	Torque wrench set with 6 spanner heads
NFT5-4	1/4" Brass caps (10 pack)
NFT5-5	5/16" Brass caps (5 pack)
A31656	5/16" Female x 1/4" SAE brass adapters (2 included)

Mini-Split Kit Tool Descriptions

NEW



22600 1/4" | 22605 5/16"
PATRIOT™ 2-valve Brass Manifold with R410A/R32/R454B Gauges
 Made in the USA



CCLS-60 1/4" | CCLS5-60 5/16"
KOBRA® Secure Seal refrigerant charging hoses with low-loss, UL-approved for R410A
 Made in the USA



TRQ1080
 7.375-59.004 pound-feet (10-80 N-M) torque wrench with six spanner heads (17, 22, 24, 26, 27, 29mm) and 1/2" DR Ratchet head
 Made in the USA



T30600
 Ratcheting eccentric cone flaring tool with internal clutch to prevent over-torquing. For tube OD: 3/16", 1/4", 5/16", 3/8", 1/2", 5/8", 3/4"



A32525N 1/4" | A32535N 5/16"
 Valve core removal tool with side port for removing valve cores without losing system charge
 Made in the USA



SHLD-P4 1/4" | SHLD-E4 5/16"
SHIELD® Refrigerant locking cap with water-resistant rubber sleeves color-coded for R410A
 Made in the USA

NEW



T30600-G
 Metal Flare Size Gauge; 1/4", 3/8", 1/2", 5/8", 3/4" SAE (6.4mm, 9.5mm, 12.7mm, 15.9mm, 19.1mm)



NFT5-4 1/4" | NFT5-5 5/16"
 Five finger-tight 1/4" o-ring sealed brass caps
 Made in the USA



A31656 1/4" | A31665 5/16" male
 Brass adapters for 5/16" - 1/4" SAE connections
 Made in the USA



T30605
 Metric (2-8mm) and Imperial (5/64" - 1/4") hex key sets
 Made in the USA



JB-BACKPACK1
 Heavy-duty canvas JB backpack



JB-TOOLBAG1
 Heavy-duty canvas JB tool bag

SHIELD®

Refrigerant Locking Caps

- Easily identifiable with water-resistant color-coded caps for R22, R410A and universal refrigerants
- Secure, tamper-resistant lock
- Protects against unauthorized access to refrigerants and deters against huffing inhalant abuse and theft
- Helps prevent leaks and excessive energy usage by providing a strong secondary seal to Schrader or backseat valve
- All brass, corrosion-resistant design
- Available with 1/4" and 5/16" fittings in packs of 4, 12, 50 and 100; also available in bulk
- Requires tamper-resistant bit and driver for unlocking
- Made in the USA 

Meets International Safety Codes

International Mechanical Code 1101.10 – Refrigerant circuit access ports located outdoors shall be fitted with locking-type tamper-resistant caps

International Residential Code M1411.6 – Refrigerant circuit access ports located outdoors shall be fitted with locking-type tamper-resistant caps

Universal Refrigerant Locking Cap Key

SHLD-MULTI Refrigerant locking cap key with interchangeable bits conveniently stored inside the tool handle. For use with SHIELD®, C&D Valve™ and Novent® Refrigerant Locking Caps.

SHIELD® Drivers

For use with SHIELD® Refrigerant Locking Caps. Available in 3" (includes one bit), 8" (includes two bits) or combination pack with both driver sizes and two bits, **SHLD-COMBO-DRIVER**.



SHLD-G4
1/4" 4 Pack (R22)

SHLD-P4
1/4" 4 Pack (R410A)



SHLD-U4
1/4" 4 Pack (Universal)



SHLD-E4
5/16" 4 Pack (Universal)



PART NO.	QTY.	FITTING SIZE	SLEEVE COLOR CODE	DESCRIPTION
SHLD-U4	4	1/4"	Universal	Locking caps and 1 bit (4 pack)
SHLD-U12	12	1/4"	Universal	Locking caps and 1 bit (12 pack)
SHLD-U50	50	1/4"	Universal	Locking caps, 1 bit and 3" driver (50 pack)
SHLD-U100	100	1/4"	Universal	Locking caps, 2 bits and 8" long driver (100 pack)
SHLD-E4	4	5/16"	Universal	Locking caps and 1 bit (4 pack)
SHLD-E12	12	5/16"	Universal	Locking caps and 1 bit (12 pack)
SHLD-E50	50	5/16"	Universal	Locking caps, 1 bit and 3" driver (50 pack)
SHLD-G4	4	1/4"	R22	Locking caps and 1 bit (4 pack)
SHLD-G12	12	1/4"	R22	Locking caps and 1 bit (12 pack)
SHLD-G50	50	1/4"	R22	Locking caps, 1 bit and 3" driver (50 pack)
SHLD-P4	4	1/4"	R410A	Locking caps and 1 bit (4 pack)
SHLD-P12	12	1/4"	R410A	Locking caps and 1 bit (12 pack)
SHLD-P50	50	1/4"	R410A	Locking caps, 1 bit and 3" driver (50 pack)

PART NO.	DESCRIPTION
SHLD-CJ	Empty storage jar holds 150 SHIELD® caps
SHLD-SLU20	Universal (black) SHIELD® sleeves (20 pack)
SHLD-SLG20	R22 (green) SHIELD® sleeves (20 pack)
SHLD-SLP20	R410A (pink) SHIELD® sleeves (20 pack)
SHLD-BIT	SHIELD® 2 pack bit
SHLD-3-DRIVER	SHIELD® 3" driver with 1 bit
SHLD-8-DRIVER	SHIELD® 8" long driver with 2 bits
SHLD-COMBO-DRIVER	SHIELD® 3" and 8" drivers with 2 bits
SHLD-MULTI	Universal locking cap key for SHIELD®, Novent® and C&D Valve™ locking caps

CoreMax®

Rapid Charge and Evacuation System

The innovative CoreMax® family of manufacturing and service tools is an integrated, flexible system design that shortens processing time and provides up to 5x greater flow. This dramatically improves sealing with faster access connections. CoreMax® gives you the choice of how you want to test, fill and evacuate your systems.

- Process directly through the valve with additional flow and dramatically better sealing
- Easy-to-use connector at every process station
- Automatic valve shutoff on both sides of connection
- Higher flow improves vacuum quality to maximize SEER rating
- Improves line throughput and reduces evacuation stations
- Easy implementation with lower tool costs
- Improves processing time and field service
- Made in the USA 

For more information and instructional video visit jbind.com



CM-VC003
High-Flow Valve Cores



CM-S370
Seats



CM-CRTOOL
Valve Core Removal Tool

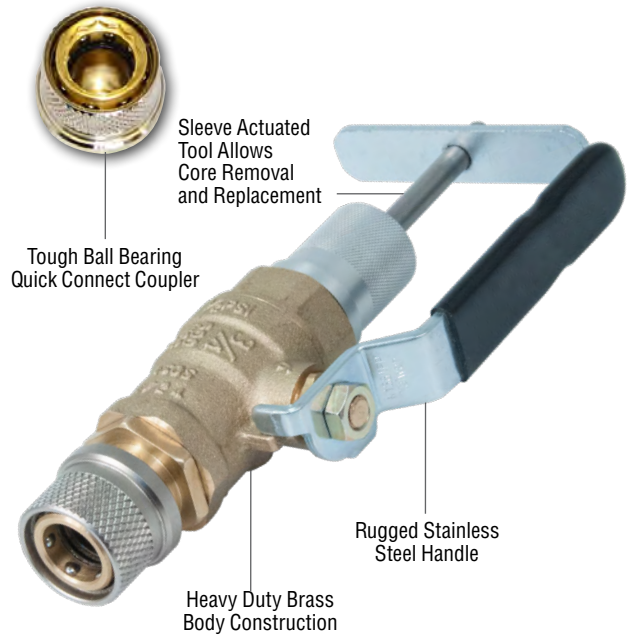

CM-TRQ
Manual Torque Wrench
3/8" Drive



CM-SNAP
SnapMate® Connector

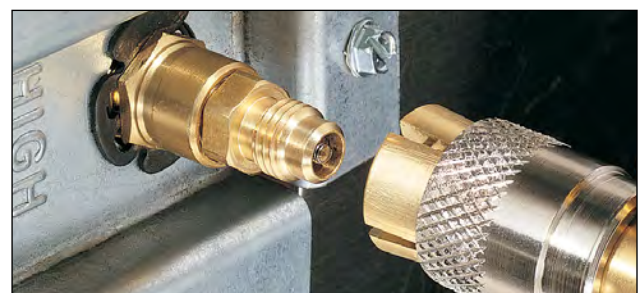

PART NO.	DESCRIPTION
CM-VC003	High-Flow Valves with Caps (3 pack)
CM-VC010	High-Flow Valves with Caps (10 pack)
CM-VC025	High-Flow Valves with Caps (25 pack)
CM-VC100	High-Flow Valves with Caps (100 pack)
CM-S370	3/8" Seats (3 pack)
CM-SS370	3/8" Saddle Seats (3 pack)
CM-S250	1/4" Seats (3 pack)
CM-SS250	1/4" Saddle Seats (3 pack)
CM-CRTOOL	Valve Core Removal Tool
CM-SEAL	Main Seal Replacement for CM-CRTOOL
CM-RBK	Rebuild Kit for CM-CRTOOL
CM-SNAP	SnapMate® Service
CM-TRQ	Manual Torque Wrench 3/8" drive

Access Valves

Access Valve Overview

100% Made in the USA 

JB machines access valves at our Aurora, Illinois facility using 100% American C360 alloy brass sourced from US mills. Our brass fittings and access valves have high tensile strength and resist corrosion. All of our valves are machined according to strict AHRI specifications to ensure proper sealing of valve and core surfaces. Quality and dependability come standard with our American-made tools.

ACCESS VALVES SPECIFICATIONS	
AHRI Standard	720-2002
AHRI Torque	3.0 - 5.0 inches/pound
Temp Range	-40°F to 250°F (-40°C to 121°C)
Valve Bodies	Brass
Valve Core	Stainless steel and brass for use with all refrigerants such as R12, R22, R134a, R410A and R502. Resistant to oils, alkalites and diluted mineral acids

Tube Sizing: ODS and ODF Fit Descriptions

Descriptions for solder/braze access valves specify the connecting tube OD. Size and type fit illustrated are examples of the types of fit for an A31723 valve. The connecting line slips around access fitting; refer to AC/R Copper Tube Fitting Guide and Connecting Tube Size table.

There are two types of ODF fit—external tube fit and swage fit. JB access valve descriptions for ODF refer to swage fit. The connecting tube OD is the same OD as the fitting end. Therefore, the A31723 example above will also slip into 5/16" OD tube. If connecting to wrought copper fitting use ODF swage size.

CONNECTING TUBE SIZE			
TUBE SIZE	ODS Internal Tube Fit	ODF External Tube Fit	ODF Swage Fit
1/8"	—	3/16"	—
3/16"	1/8"	1/4"	3/16"
1/4"	3/16"	5/16"	1/4"
5/16"	1/4"	3/8"	5/16"
3/8"	5/16"	—	3/8"

For easy sizing reference the last two numerals of our flare fittings correspond to their respective tube sizes.

SIZING REFERENCE GUIDE			
NUMBER	TUBE SIZE	NUMBER	TUBE SIZE
02	1/8"	08	1/2"
03	3/16"	10	5/8"
04	1/4"	12	3/4"
05	5/16"	14	7/8"
06	3/8"	18	1-1/8"

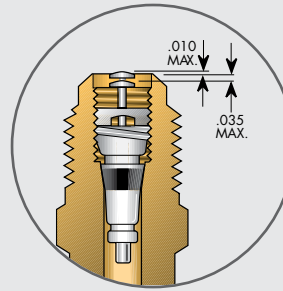

Valve Core Pin Location

After valve installation the valve core can be replaced with valve core tools. Torque to AHRI specifications.

Multi-Step Variants

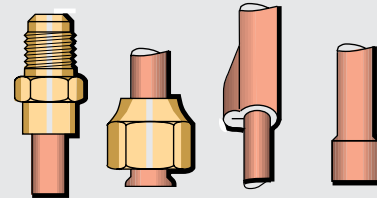

Cut Flare Pinch Swage

Copper Braze Tees

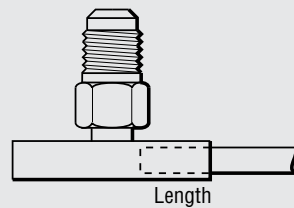

Length

Copper Access Unions

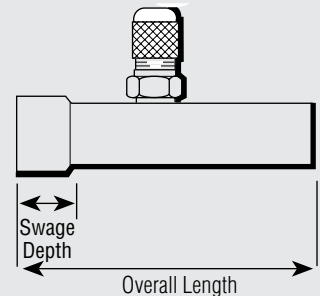

Swage Depth

Overall Length

AC/R Copper Tube Fitting Guide

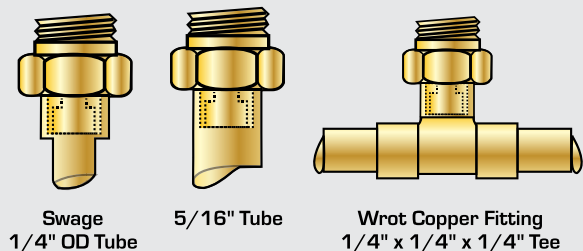
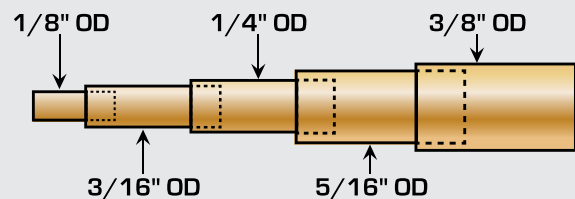

Copper Tube Extension Single Step

- For use with Sil-Fos alloy and copper fittings
- Includes 1/4" ID cap (NFT5-4) and valve core
- Generous counterbore allows removal of core if flare becomes damaged
- All tees and crosses are tapped to receive an access core in all 1/4" SAE flare ends
- All pipe connections have internal braze cups for dip tube applications
- Made in the USA 

Note: OD x ID sizes are for copper tube extension

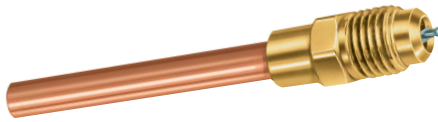

A31004



PART NO.	QTY.	DESCRIPTION
A31002	5	1/8" OD
A31003	5	3/16" OD x 1/8" ID
A31004	5	1/4" OD x 3/16" ID
A31005	5	5/16" OD x 1/4" ID
A31006	5	3/8" OD x 5/16" ID
A31008	3	1/2" OD
A31004S	5	1/4" OD

Copper Tube Extension Multi-Step

- For use with Sil-Fos alloy and copper fittings
- Includes 1/4" ID cap (NFT5-4) and valve core
- Generous counterbore allows removal of core if flare becomes damaged
- All tees and crosses are tapped to receive an access core in all 1/4" SAE flare ends
- All pipe connections have internal braze cups for dip tube applications
- Made in the USA 

Note: OD x ID sizes are for copper tube extension



A31009

PART NO.	QTY.	DESCRIPTION
A31009	3	1/8" OD ext; 3/16", 1/4" and 5/16" ODF body steps
A31011	3	3/16" OD ext; 1/4" and 3/8" ODF body step
A31012	3	1/8" OD ext.; 1/8" and 3/16" body step

Copper Braze Tapper Only

- Made in the USA 

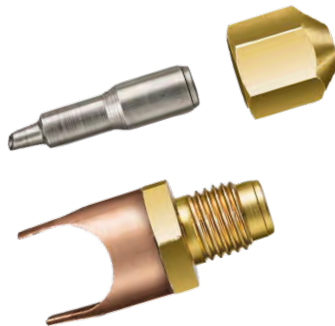

A32804

PART NO.	QTY.	DESCRIPTION
A32804	5	1/4"
A32805	5	5/16"
A32806	5	3/8"
A32808	3	1/2"
A32810	3	5/8"
A32812	2	3/4"
A32814	2	7/8"
A32818	2	1-1/8"

Copper Braze Saddle with Tapper

- Made in the USA 

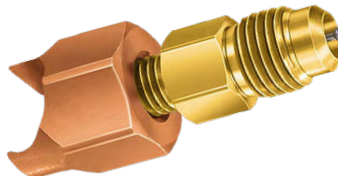

A32904

PART NO.	QTY.	DESCRIPTION
A32904	5	1/4"
A32905	5	5/16"
A32906	5	3/8"
A32908	3	1/2"
A32910	3	5/8"
A32912	2	3/4"
A32914	2	7/8"

Copper 90° Elbow

- Includes cap (NFT5-4) and valve core
- Use Sil-Fos alloy only
- Made in the USA 



A31160

PART NO.	QTY.	SLIP-FIT CONNECT LINE SIZE
A31160	1	5/8" ODS
A31162	1	3/4" ODS
A31164	1	7/8" ODS
A31168	1	1-1/8" ODS

Copper Braze Tee

Adjustable

- Bend, cut, flare, swage or pinch; extra depth slip fit braze cups
- Simple installation anywhere along the line
- Use Sil-Fos alloy only
- Made in the USA 

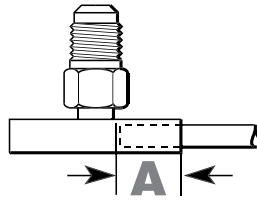
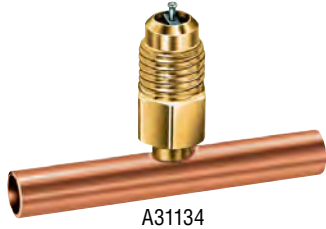



Figure 1. Copper Braze Tees

PART NO.	QTY.	SLIP-FIT CONNECT LINE SIZE	OVER ALL LENGTH (OAL)	LENGTH FIG 1. (A)
A31134	3	1/4" ODS x 5/16" ODF	2-1/8"	1"
A31135	3	5/16" ODS x 3/8" ODF	2-1/8"	1"
A31136	3	3/8" ODS x 1/2" ODF	2-1/8"	1"
A31138	3	1/2" ODS	2-1/8"	1"
A31140	1	5/8" ODS	2-1/2"	1"
A31142	1	3/4" ODS	3"	1-1/4"
A31144	1	7/8" ODS	3-1/2"	1-1/2"
A31148	1	1-1/8" ODS	3-13/16"	1-5/8"
A31154	2	3/16" ODS x 1/4" ODF	4"	1-15/16"
A31155	2	1/4" ODS x 5/16" ODF	4"	1-15/16"
A31156	2	5/16" ODS x 3/8" ODF	4"	1-15/16"

Copper Access Union

- Includes cap (NFT5-4) and valve core
- Install valve in any position
- Connecting line size for ODS and ODF external tube ends
- Use Sil-Fos alloy only
- Made in the USA 

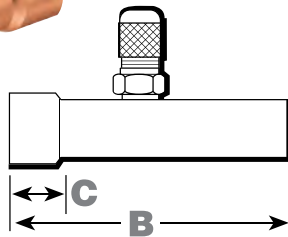
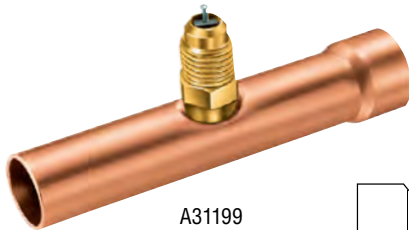

Figure 2. Copper Access Unions

PART NO.	QTY.	SLIP-FIT CONNECT LINE SIZE	OVER ALL LENGTH (OAL) FIG 2. (B)	MIN. LENGTH (MIN) FIG 2. (C)
A31199	2	1/4" OD	2-3/8"	5/16"
A31200	2	3/8" OD	2-3/4"	5/16"
A31201	2	1/2" OD	3"	3/8"
A31202	2	5/8" OD	3-1/4"	1/2"
A31204	2	7/8" OD	3-3/4"	3/4"

Copper Braze Tee

Swaged

- Braze cup ends
- Simple installation anywhere along the line
- Use Sil-Fos alloy only
- Made in the USA 



A31334

PART NO.	QTY.	SLIP-FIT CONNECT LINE SIZE	OVER ALL LENGTH (OAL)
A31334	3	1/4" OD	2-1/8"
A31335	3	5/16" OD	2-1/8"
A31336	3	3/8" OD	2-1/8"
A31338	3	1/2" OD	2-1/8"
A31340	1	5/8" OD	2-1/2"
A31342	1	3/4" OD	3"
A31344	1	7/8" OD	3-1/2"
A31348	1	1-1/8" OD	3-13/16"

Access Valve Service Kit

- The most popular access fittings for service calls in one convenient storage case. Includes: A31002 (3), A31003 (3), A31004 (3), A31005 (3), A31006 (3), NFT5-4 (6), A31851 (1), A31852 (1), A32004 (1), A31998 (3), A33500 (1), A31729 (3)
- Made in the USA 



AVK-001

PART NO.	DESCRIPTION
AVK-001	Access valve service kit in storage case

Bulk Fitting Jar

- Best selling access valves packaged in a convenient display jar
- Made in the USA 



A31004-CJ

PART NO.	QTY.	DESCRIPTION
A31004-CJ	250	1/4" OD x 3/16" ID copper tube extension with bulk jar
NFT5-4-CJ	500	1/4" SAE cap with bulk jar

Swivel Flare Connections Add Multiple Ports with One Fitting

- Safe, simple installation without the need for brazing
- Flare ends are tapped to receive access cores
- One core and cap are packaged with each valve



Swivel Flare with Core Depressor

- Add a new line or control
- No refrigerant loss on charged system

Swivel Flare without Core Depressor

- Multiple ports
- Additional line or controls
- Additional access site

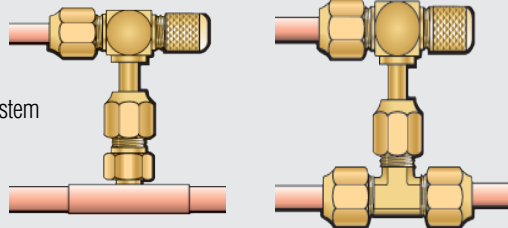

Swivel Flare Tee with Depressor

- Made in the USA

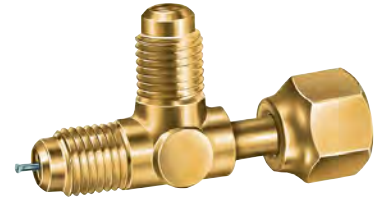

A31851

PART NO.	QTY.	DESCRIPTION
A31851	3	1/4" Female SAE swivel nut on run
A31852	3	1/4" Female SAE swivel nut on branch

Swivel Flare Tee without Depressor

- Made in the USA



A31854

PART NO.	QTY.	DESCRIPTION
A31854	3	1/4" Female SAE swivel nut on branch
A31864	3	1/4" FE swivel nut w/o depressor x 1/4" SAE run x 1/4" SAE branch

Swivel Flare 3/8" SAE Tee

- Made in the USA

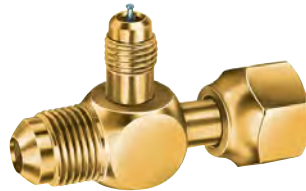

A31853

PART NO.	QTY.	DESCRIPTION
A31853	1	3/8" SAE x 3/8" Female SAE swivel nut x 1/4" access tee
A31856	1	3/8" SAE x 1/4" access x 3/8" Female SAE swivel nut

Coupler with Depressor

- Made in the USA



A33004

PART NO.	QTY.	DESCRIPTION
A33004	1	1/4" SAE swivel flare x male flare

Bulkhead Mounting

- Made in the USA

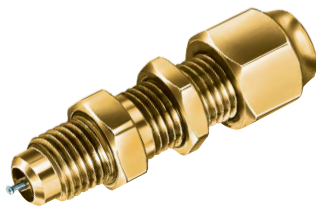

A31434

PART NO.	QTY.	DESCRIPTION
A31434*	1	1/4" SAE x 1/4" SAE w/nut
A31727*	1	1/4" SAE x 3/16" and 1/4" ODS or 3/8" ODF

Swivel Cross with Depressor

- Made in the USA

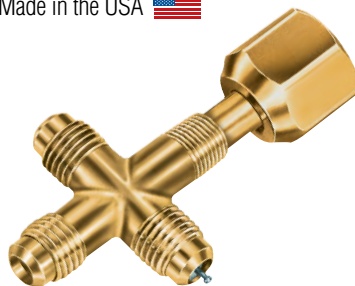

A31520

PART NO.	QTY.	DESCRIPTION
A31520	1	1/4" Female SAE swivel nut x access

Cross with Three Access Points

- Made in the USA



A31522

PART NO.	QTY.	DESCRIPTION
A31522	1	1/8" MPT cross

*Core pre-torqued to AHRI
PRODUCT CATALOG 55 | 800.323.0811 | 630.851.9444 | SALES@JBIND.COM

Access Valves

JB INDUSTRIES

PRO TIPS

MPT Connections

Most MPT Connections have internal braze cup for dip tube installation

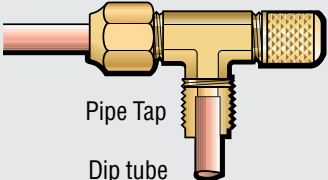

Pipe Tap
Dip tube

MPT Connection

• Made in the USA



A31482

PART NO.	QTY.	DESCRIPTION
A31482*	5	1/4" Flare x 1/8" MPT Half Union
A31484*	5	1/4" Flare x 1/4" MPT Half Union
A31492*	3	1/4" Flare x 1/8" MPT Elbow
A31494*	3	1/4" Flare x 1/4" MPT Elbow

*Core pre-torqued to AHRI

MPT Tee Connection

• Made in the USA



A31452

PART NO.	QTY.	DESCRIPTION
A31452	3	1/8" MPT x 1/4" SAE Branch Tee
A31454	3	1/4" MPT x 1/4" SAE Branch Tee
A31512	3	1/8" MPT run
A31514	3	1/4" MPT x 1/4" SAE Run x 1/4" SAE Branch Tee

MPT Forged Brass Braze Tee

• Made in the USA



A31234

PART NO.	QTY.	DESCRIPTION
A31234	3	1/4" ODS x 3/8" ODF
A31235	3	5/16" ODS x 3/8" ODF
A31236	3	3/8" ODS x 1/2" ODF
A31238	3	1/2" ODS x 5/8" ODF

MPT Flared Tube Connection

• Made in the USA



A31424

PART NO.	QTY.	DESCRIPTION
A31424*	3	1/4" Female SAE union w/flare nut
A31444	3	1/4" Female SAE union w/flare nut

*Core pre-torqued to AHRI

MPT Flare Connection and Flare Fitting Adapter

• Made in the USA



A31734

PART NO.	QTY.	DESCRIPTION
A31614*	5	1/4" Female SAE w/copper gasket
A31734*	3	1/4" Female SAE swivel nut w/depressor

*Core pre-torqued to AHRI

MPT Brass Bodies

• Made in the USA



A31722

PART NO.	QTY.	DESCRIPTION
A31722	3	1/8" ODS x 1/4" ODF
A31723	3	3/16" ODS x 1/4" ODF
A31724	3	1/4" ODS x 3/8" ODF
A31725	3	5/16" ODS x 1/2" ODF
A31726	3	3/8" ODS x 1/2" ODF
A31728	3	1/2" ODS x 5/8" ODF

MPT Multi-Step

• Made in the USA



A31720



A31729

PART NO.	QTY.	DESCRIPTION
A31720	5	3/16" ODS x 1/4" or 3/8" ODF steps
A31729	3	3/16", 1/4", 5/16", 1/2" ODF steps
A31736	3	1/8" ODS x 3/16", 1/4" or 5/16" ODF

A32525SV

NEW

Valve Core Removal Tool with Slide Valve Side Port

Designed with the daily job of technicians in mind—The Dealer Design Award-winning A32525SV valve core removal tool utilizes an additional slide valve side port to accommodate a vacuum gauge.

Primary function is to remove and replace the valve core under pressure and/or to remove valve cores in refrigeration systems to increase evacuation and charging performance.

- Swap out damaged valve cores under pressurized air conditioning and refrigeration systems for much faster evacuation
- Slide valve side port valve provides an excellent location to attach a vacuum gauge so system can be checked for absence of moisture and air
- Slide valve side port provides an easy open/close so vacuum gauge can be removed without the introduction of air into the system before charging
- Protect sensitive vacuum gauge sensors when left on during the charging process by closing slide valve side port
- In-line actuated handle allows the contractor to open and close the valve in tight areas with a single finger
- Uses a series of o-rings and precision machining to stay sealed and not leak during evacuation
- Solid brass construction with the tip machined from A2 tool steel extends tool life
- Made in the USA 

A32525SVT

NEW

Valve Core Removal Tool with Slide Valve Side Port and Torque Setting

Designed with the daily job of technicians in mind—The A32525SVT valve core removal tool utilizes an additional slide valve side port to accommodate a vacuum gauge.

Primary function is to remove and replace the valve core under pressure and/or to remove valve cores in refrigeration systems to increase evacuation and charging performance.

- Swap out damaged valve cores under pressurized air conditioning and refrigeration systems for much faster evacuation
- The A32525SVT automatically sets torque 3 to 5 in-lb
- Slide valve side port valve provides an excellent location to attach a vacuum gauge so system can be checked for absence of moisture and air
- Slide valve side port provides an easy open/close so vacuum gauge can be removed without the introduction of air into the system before charging
- Protect sensitive vacuum gauge sensors when left on during the charging process by closing slide valve side port
- In-line actuated handle allows the contractor to open and close the valve in tight areas with a single finger
- Uses a series of o-rings and precision machining to stay sealed and not leak during evacuation
- Solid brass construction with the tip machined from A2 tool steel extends tool life
- Made in the USA 



VACUUM RATED

Slide Valve Side Port slides open and close protecting attached vacuum gauge

In-Line Actuated Handle for easy open/close



Easily attaches, protects the vacuum gauge.

PART NO.	DESCRIPTION
A32525SV	1/4" x 1/4" Valve Core Removal Tool with Slide Valve Side Port
A32535SV	5/16" x 1/4" Valve Core Removal Tool with Slide Valve Side Port
P325	Replacement o-rings



VACUUM RATED

Slide Valve Side Port slides open and close protecting attached vacuum gauge

In-Line Actuated Handle for easy open/close

AUTOMATICALLY SETS TORQUE 3 to 5 in-lb



Easily attaches, protects the vacuum gauge, and eliminates over tightening

PART NO.	DESCRIPTION
A32525SVT	1/4" x 1/4" Valve Core Removal Tool with Slide Valve Side Port and Torque Setting; 3 to 5 in-lb
A32535SVT	5/16" x 1/4" Valve Core Removal Tool with Slide Valve Side Port and Torque Setting; 3 to 5 in-lb
P325	Replacement o-rings

Access Valves

JB INDUSTRIES

Vacuum Rated Valve Core Removal Tool with Access Port

- Vacuum rated to 20 microns with quarter-turn ball valve shutoff and o-ring seals
- Speeds up evacuation, recovery or recharging through the full flow port
- Storage area for spare valve cores
- Made in the USA 

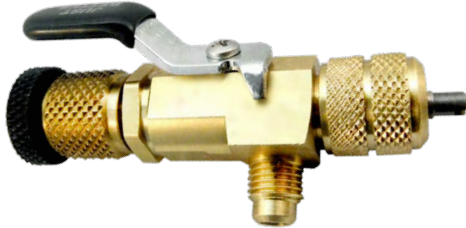

A32525N

PART NO.	QUICK CONNECT	FLARE RUN	SIDE PORT
A32500N	1/4"	1/4"	—
A32505N	5/16"	1/4"	—
A32525N	1/4"	1/4"	1/4"
A32530N	5/16"	1/4"	1/4"
A32535N	5/16"	5/16"	1/4"
A32501N	Core remover bit for A32500N replacement		
A32504	Core remover bit for A32525N replacement		
P325	1/4" and 5/16" replacement gaskets for A32525N (1 each)		

Valve Cores and Tool

- Positive stop valve core with neoprene cup washer and PTFE barrel gasket seal for A/C system valves
- Installation torque 3 to 5 in/lbs
- Max 800 psi and 220°F (104°C)
- Made in the USA 



A32004

A31999

PART NO.	QTY.	DESCRIPTION
A32004	1	1/4" Valve core tool with storage for six valve cores
A31999	5	1/4" Valve cores
A31999-25	25	1/4" Valve cores
A31999-100	100	1/4" Valve cores

Valve Core Torque Tool

- Preset torque to 5 in/lbs for precise torquing of core valves
- Works with all standard valve cores



A32008-BX

A32008

PART NO.	QTY.	DESCRIPTION
A32008	1	1/4" Valve core torque tool
A32008-B	12	1/4" Valve core torque tools in bulk
A32008-BX	12	1/4" Valve core torque tools in display box

Evacuation Recovery Tool

- Plier-type tool with a quick-release trigger to puncture large holes into the line for discharge of a recovery unit
- Fits 3/16" to 7/8" OD hard tubing



A32100

PART NO.	QTY.	DESCRIPTION
A32100	1	Evacuation/recovery tool
A32101	1	Hardened steel needle and gasket

Quick Seal O-Ring Caps

- Deep vacuum and A/C refrigeration
- Finger-tight sealing for all male SAE connections
- Made in the USA 



NFT5-4

PART NO.	QTY.	DESCRIPTION
NFT5-4	10	1/4" SAE cap
NFT5-5	5	5/16" SAE cap
NFT5-6	3	3/8" SAE cap
NFT5-8	3	1/2" SAE cap
NFT5-4-25	25	1/4" SAE cap
NFT5-4-100	100	1/4" SAE cap
NFT5-6-100	100	3/8" SAE cap
P90010	10	Replacement 1/4" o-ring
P90011	5	Replacement 5/16" o-ring

Quick Seal Gasket Caps

- Deep vacuum and A/C refrigeration
- Finger-tight sealing for all male SAE connections
- Made in the USA 



A31985

PART NO.	QTY.	DESCRIPTION
A31985	10	1/4" SAE cap
A31985-100	100	1/4" SAE cap
P509	6	1/4" Replacement gasket
P509-25	25	1/4" Replacement gasket

E-Z Tapper

- Backseating stem eliminates line restriction when servicing through access port or when using the valve for flow control
- Made in the USA 



EZ-40288

PART NO.	QTY.	DESCRIPTION
EZ-40288	1	E-Z tapper piercing valve 3/16" x 3/8" OD tube
EZ-40288-126	5	E-Z tapper gasket

Backseating Control Valve

- Ideal for use on pre-charged line sets
- Stops spray of leak detection dye/refrigerant
- Compact brass body for long service and swivel coupler with double safety grooves
- Made in the USA 



A33000

PART NO.	QTY.	DESCRIPTION
A33000	1	1/4" SAE x 1/4" o-ring quick coupler
P90009	10	Replacement o-ring

Core Removers

- Made in the USA 



A31997



A31998

PART NO.	QTY.	DESCRIPTION
A31997	10	1/4" Core remover cap
A31998	5	1/4" Plastic core removers

O-Ring Seal Line Piercing

- Spring-loaded needle automatically backseats forming a leakproof seal
- Simple installation that is 100% restriction-free
- Made in the USA 



LT-456

PART NO.	DESCRIPTION
LT-456	1/4" – 3/8" Line piercing valve
LT-810	1/2" – 5/8" Line piercing valve

Wrench Style Seal Cap

- For A/C refrigeration service
- Brass-to-brass positive seal and permanent installation
- Made in the USA 



A31986

PART NO.	QTY.	DESCRIPTION
A31986	5	1/4" SAE cap

Specialty Caps

- Made in the USA 



A31992

PART NO.	QTY.	DESCRIPTION
A31992	5	1/4" SAE cap
A31992-100	100	1/4" SAE cap
13493	2	Plastic cap with retainer strap
13494	1	Plastic cap

QC Angled Adapter 45°

- Made in the USA 



QC-S45-45

PART NO.	DESCRIPTION
QC-S45-45	5/16" Female x 1/4" SAE Male Angled Adapter 45°

QC Straight

- Made in the USA 



QC-S4

PART NO.	DESCRIPTION
QC-S3	3/16" QC x 1/4" SAE
QC-S4	1/4" QC x 1/4" SAE
QC-S46	1/4" QC x 3/8" SAE
QC-S5	5/16" QC x 1/4" SAE
QC-S5S	5/16" QC x 1/4" SAE (w/valve core)
QC-S64	3/8" QC x 1/4" SAE (no depressor)
QC-S65	3/8" QC x 5/16" SAE (no depressor)

QC Female NPT Thread

- Made in the USA 



QC-S4A

PART NO.	DESCRIPTION
QC-S4A	1/4" QC x 1/8" Female NPT
QC-S4B	1/4" QC x 1/4" Female NPT

QC Elbow

- Made in the USA 



QC-E3

PART NO.	DESCRIPTION
QC-E3	3/16" QC x 1/4" SAE elbow
QC-E4	1/4" QC x 1/4" SAE elbow
QC-E5	5/16" QC x 1/4" SAE elbow
QC-E64	3/8" QC x 1/4" SAE elbow (no depressor)

QC SAE Female Adapter

- Made in the USA 



A31656

PART NO.	DESCRIPTION
A31656	1/4" SAE Male x 5/16" SAE Female Adapter
A31665	5/16" SAE Male x 1/4" SAE Female Adapter

QC Access Tee

- O-ring seal quick coupler
- Includes cap and valve core
- Made in the USA 



A34000

PART NO.	QTY.	DESCRIPTION
A34000	1	1/4" QC x 1/4" access branch tee
P90009	10	Replacement o-ring

Core Depressor

- Made in the USA 



A33500

PART NO.	DESCRIPTION
A33500	1/4" Thumbscrew core depressor
P90009	Replacement o-ring

Liquid Charging Adapters

- Metering element assures a safe, fast charge without damaging the compressor
- Made in the USA 



LC-4/LC-5

PART NO.	DESCRIPTION
LC-4	1/4" Liquid charging adapter
LC-5	5/16" Liquid charging adapter

Swivel Cylinder Valve

- O-ring seal quick coupler
- Includes cap and valve core
- Made in the USA 



CV-20004

PART NO.	DESCRIPTION
CV-20004	3/4" NPS x 1/4" M flare
CV-20006	3/4" NPS x 3/8" M flare

O-Rings/Gaskets

Replacement Parts

• Made in the USA 



P90009



P90010



P90012



P90016

PART NO.	QTY.	DESCRIPTION
A10974	1	O-ring/Gasket Removal Tool NEW
P509	6	1/4" Gasket for quick couplers, gasket caps (6 pack)
P325	2	1/4" and 5/16" replacement gaskets for A32525N (1 each)
P509-25	25	1/4" Gasket for quick couplers, gasket caps (25 pack)
P510	6	1/4" CLA Series R134a gasket (6 pack)
P511	6	Gasket for 1/4" CLE, CLV, CLBV Series hose (6 pack)
P511-10	10	Gasket for 1/4" CLE, CLV, CLBV Series hose (10 pack)
P90008	5	Gasket for 1/2" heavy-duty black charging hose (5 pack)
P90009	10	1/4" O-ring for couplers, vacuum pumps and flexible metal hose (10 pack)
P90010	5	1/4" O-ring for access valves and liquid charging adapters, 1/4" caps (5 pack)
P90011	5	5/16" O-ring for liquid charging adapters (5 pack)
P90012	10	3/8" O-ring for couplers, vacuum pumps and flexible metal hose (10 pack)
P90016	10	Gasket for 3/8" hose (10 pack)
P90022	10	O-ring for T21295 and 33112RK (10 pack)
P90513	5	1/4" Spring type clip depressor for coupler; used with P509 (5 pack)
P90514	5	1/4" Depressor for CLE, CLV and CLBV Series used with P511 (5 pack)



P90513



P509



P90514



P511



A10974

American-made Brass

SAE 45° Flared Tube Fittings

JB fittings are for use with copper, brass, aluminum, steel and plastic tube provided an acceptable flare can be generated with the material.

Vacuum and pressures of 5,000 psi can be handled depending upon the size, material and conditions. Using a 4:1 safety factor, the following general rule (excluding plastic tube) is used:

3,000 psi to 1/4" 2,000 psi to 1/2" 1,500 psi to 1"

Long nuts are recommended when vibration is a factor. Tubing should be double-flared in extreme applications to minimize flare thinning on over-tightening.

Fittings listed generally comply with SAE, ASA, ASME and MS standards; however, when design makes dimensions critical, please contact customer service for samples and/or prints for testing and evaluation.

Tube sizes listed are OD (outside diameter). To determine nominal (water tube) size, subtract 1/8", thus 5/8" OD equals 1/2" nominal. Pipe sizes listed are standard nominal pipe size and threads are to dry seal taper pipe standards. JB will provide flare fitting to SAE Standard J513 whenever possible. In some cases slight deviations will occur when full compliance fittings are not available.

Heavy-duty ACR tube fittings generally conform to SAE, ASA and AHRI Standards for hydraulic, marine and refrigeration service. Long dry seal pipe threads minimize leakage and provide more clearance for tightening flare nuts. Shapes, elbows, tees, etc. are made from brass forgings to maximize strength and eliminate cracks.

Assembly Instructions

1. Cut tube square and remove cut-off burr
 2. Slide nut on tube, threaded end facing end of tube
 3. Flare tube following flaring tool manufacturers instructions (check flare quality)
 4. Thread nut on to fitting body "hand tighten"
 5. With proper wrench, tighten to a solid feel
- CAUTION: Over-tightening and dirt can damage fittings and/or tube causing leaks.

NOTE: Lubrication of flare faces and threads is recommended when practical.

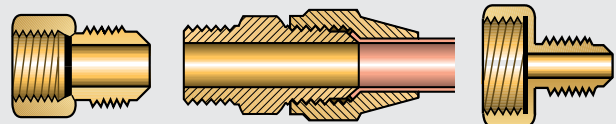

Copper seal gaskets (B2) series furnished with all female flares

Fiber gaskets (K1 and D/E) furnished with all drum adapters (K1-1 through 8)

THREAD SIZE OF TUBE ENDS			
OD TUBE	SAE - FLARE	OD TUBE	SAE FLARE
1/8"	5/16" - 24	1/2"	3/4" - 16
3/16"	3/8" - 24	5/8"	7/8" - 14
1/4"	7/16" - 20	3/4"	1-1/16" - 14
5/16"	1/2" - 20	7/8"	1-1/4" - 12
3/8"	5/8" - 18	1"	1-3/8" - 12
7/16"	11/16" - 16	—	—

TORQUE POUNDS FOR FLARE FITTING (DRY THREAD)	
SIZE	FT/LBS
1/4"	8-10
3/8"	15-25
1/2"	25-35
5/8"	40-55
3/4"	50-60



Brass Fittings

JB INDUSTRIES

Copper Flare Bonnet

- Use with flare nut to cap fittings
- Made in the USA 



B1-3

PART NO.	QTY.	SIZE
B1-3	5	3/16"
B1-4	25	1/4"
B1-6	5	3/8"
B1-8	5	1/2"
B1-10	10	5/8"
B1-12	5	3/4"

Swivel Female Flare x Solder Adapter

- Made in the USA 



A32700

PART NO.	QTY.	DESCRIPTION
A32700	4	1/4" x 1/4" (US5-44)
A32701	4	3/8" x 3/8" (US5-66)
A32702	4	1/2" x 1/2" (US5-88)
A32703	2	5/8" x 5/8" (US5-1010)
A32704	2	3/4" x 3/4" (US5-1212)

Swivel Female Flare x Solder Adapter

- Made in the USA 



US5-1212

PART NO.	QTY.	SIZE
US5-44	5	1/4" x 1/4"
US5-66	5	3/8" x 3/8"
US5-88	5	1/2" x 1/2"
US5-1010	5	5/8" x 5/8"
US5-1212	2	3/4" x 3/4"

Copper Flare Gasket

- For brass-to-brass or brass-to-steel connections to prevent leaks
- Made in the USA 



B2-3

PART NO.	QTY.	SIZE
B2-3	5	3/16"
B2-4	25	1/4"
B2-5	5	5/16"
B2-6	25	3/8"
B2-8	25	1/2"
B2-10	10	5/8"
B2-12	10	3/4"

Short Forged Nut

- Made in the USA 



A32600

PART NO.	QTY.	DESCRIPTION
A32600	10	1/4" (NS4-4)
A32601	5	5/16" (NS4-5)
A32602	10	3/8" (NS4-6)
A32603	5	1/2" (NS4-8)
A32604	5	5/8" (NS4-10)
A32605	2	3/4" (NS4-12)

Short Forged Nut

- Made in the USA 



NS4-14

PART NO.	QTY.	SIZE
NS4-3	10	3/16"
NS4-4	25	1/4" (A32600)
NS4-4-CS	1000	1/4" (A32600)
NS4-5	10	5/16" (A32601)
NS4-6	25	3/8" (A32602)
NS4-6-CS	500	3/8" (A32602)
NS4-8	25	1/2" (A32603)
NS4-8-CS	350	1/2" (A32603)
NS4-10	10	5/8" (A32604)
NS4-10-CS	200	5/8" (A32604)
NS4-12	5	3/4" (A32605)
NS4-12-CS	100	3/4" (A32605)
NS4-14	2	7/8"

Flare x Female Solder Ell

- For brass-to-brass or brass-to-steel connections to prevent leaks
- Made in the USA 



ES2-44

PART NO.	QTY.	SIZE
ES2-44	5	1/4" x 1/4"
ES2-66	5	3/8" x 3/8"
ES2-68	2	3/8" x 1/2"
ES2-88	2	1/2" x 1/2"

Female Flare x Flare Ell

- Includes copper gasket
- Made in the USA 



E4-44

PART NO.	QTY.	SIZE
E4-44	5	1/4" x 1/4"
E4-66	2	3/8" x 3/8"
E4-88	2	1/2" x 1/2"

Flare x Male Pipe Ell

• Made in the USA 



E1-12E

PART NO.	QTY.	SIZE
E1-2A	5	1/8" x 1/8"
E1-3A	2	3/16" x 1/8"
E1-4A	10	1/4" x 1/8"
E1-4B	10	1/4" x 1/4"
E1-4C	5	1/4" x 3/8"
E1-5A	5	5/16" x 1/8"
E1-5B	5	5/16" x 1/4"
E1-5C	5	5/16" x 3/8"
E1-6A	5	3/8" x 1/8"
E1-6B	10	3/8" x 1/4"
E1-6C	10	3/8" x 3/8"

PART NO.	QTY.	SIZE
E1-6D	5	3/8" x 1/2"
E1-6E	2	3/8" x 3/4"
E1-8B	5	1/2" x 1/4"
E1-8C	5	1/2" x 3/8"
E1-8D	10	1/2" x 1/2"
E1-8E	2	1/2" x 3/4"
E1-10C	2	5/8" x 3/8"
E1-10D	2	5/8" x 1/2"
E1-10E	2	5/8" x 3/4"
E1-12D	2	3/4" x 1/2"
E1-12E	2	3/4" x 3/4"

Flare Ell

• Made in the USA 



E2-2

PART NO.	QTY.	SIZE
E2-2	5	1/8"
E2-3	5	3/16"
E2-4	5	1/4"
E2-5	5	5/16"
E2-6	5	3/8"
E2-8	5	1/2"
E2-10	2	5/8"
E2-12	2	3/4"

Reducing Flare Ell

• Made in the USA 



ER2-64

PART NO.	QTY.	SIZE
ER2-64	5	3/8" x 1/4"
ER2-84	2	1/2" x 1/4"
ER2-86	5	1/2" x 3/8"
ER2-108	2	5/8" x 1/2"

Swivel Female Flare x Flare Ell

• Made in the USA 



ES4-44

PART NO.	QTY.	SIZE
ES4-44	2	1/4" x 1/4"
ES4-66	2	3/8" x 3/8"
ES4-88	2	1/2" x 1/2"
ES4-1010	2	5/8" x 5/8"
ES4-1212	2	3/4" x 3/4"

Flare x Female Pipe Ell

• Made in the USA 



E3-5B

PART NO.	QTY.	SIZE
E3-4A	5	1/4" x 1/8"
E3-4B	2	1/4" x 1/4"
E3-5B	2	5/16" x 1/4"
E3-6A	5	3/8" x 1/8"
E3-6B	2	3/8" x 1/4"
E3-6C	2	3/8" x 3/8"
E3-6D	2	3/8" x 1/2"
E3-8C	2	1/2" x 3/8"
E3-8D	2	1/2" x 1/2"
E3-8E	2	1/2" x 3/4"
E3-10D	2	5/8" x 1/2"
E3-10E	2	5/8" x 3/4"

Brass Fittings

JB INDUSTRIES

Fusible Pipe Plug

- Made in the USA 



FP-C-283



PART NO.	SIZE	QTY.
168°F		
FP-A-168	1/8"	5
FP-B-168	1/4"	5
FP-C-168	3/8"	2
210°F		
FP-A-210	1/8"	5
FP-B-210	1/4"	5
FP-C-210	3/8"	2
283°F		
FP-A-283	1/8"	5
FP-B-283	1/4"	2
FP-C-283	3/8"	2

Flare Cap

- Made in the USA 



N5-4

PART NO.	QTY.	SIZE
N5-3	5	3/16"
N5-4	25	1/4"
N5-5	5	5/16"
N5-6	25	3/8"
N5-8	10	1/2"
N5-10	10	5/8"
N5-12	2	3/4"

Fusible Flare x Pipe Adapter

- Made in the USA 



FU-4C-210



PART NO.	SIZE	QTY.
168°F		
FU-4B-168	1/4" x 1/4"	2
FU-6C-168	3/8" x 3/8"	2
210°F		
FU-4B-210	1/4" x 1/4"	2
FU-4C-210	1/4" x 3/8"	2
FU-6C-210	3/8" x 3/8"	2
283°F		
FU-4B-283	1/4" x 1/4"	2
FU-4C-283	1/4" x 3/8"	2
FU-6C-283	3/8" x 3/8"	2

Old Style Extra Heavy Nut

- Made in the USA 



HNS4-12

PART NO.	QTY.	SIZE
HNS4-4	25	1/4" (3/4" hex)
HNS4-6	25	3/8" (7/8" hex)
HNS4-8	10	1/2" (1" hex)
HNS4-10	10	5/8" (1-1/8" hex)
HNS4-12	2	3/4" (1-3/8" hex)

Cross

- Made in the USA 



C1-6

PART NO.	QTY.	SIZE
C1-4	2	1/4"
C1-6	2	3/8"

Frost-Proof Forged Nut

- Holes relieve frost in thread area
- Made in the USA 



NST4-10

PART NO.	QTY.	SIZE
NST4-4	5	1/4"
NST4-6	5	3/8"
NST4-8	10	1/2"
NST4-10	2	5/8"

Long Forged Refrigeration Nut

- Made in the USA 



N4-12

PART NO.	QTY.	SIZE
N4-4	10	1/4"
N4-5	5	5/16"
N4-6	10	3/8"
N4-8	5	1/2"
N4-10	5	5/8"
N4-12	2	3/4"

Flare x Flare x Male Pipe Tee

- Made in the USA 



T1-10D

PART NO.	QTY.	SIZE
T1-4A	10	1/4" x 1/4" x 1/8"
T1-4B	10	1/4" x 1/4" x 1/4"
T1-4C	2	1/4" x 1/4" x 3/8"
T1-5B	2	5/16" x 5/16" x 1/4"
T1-6B	5	3/8" x 3/8" x 1/4"
T1-6C	5	3/8" x 3/8" x 3/8"
T1-6D	2	3/8" x 3/8" x 1/2"
T1-8B	2	1/2" x 1/2" x 1/4"
T1-8C	2	1/2" x 1/2" x 3/8"
T1-8D	2	1/2" x 1/2" x 1/2"
T1-10C	2	5/8" x 5/8" x 3/8"
T1-10D	2	5/8" x 5/8" x 1/2"

Flare Tee

- Made in the USA 



T2-12

PART NO.	QTY.	SIZE
T2-3	5	3/16"
T2-4	10	1/4"
T2-5	5	5/16"
T2-6	10	3/8"
T2-8	5	1/2"
T2-10	2	5/8"
T2-12	2	3/4"

Refrigerant Drum Adapter

- NPS cylinder x male flare; with fiber gasket
- Made in the USA 



K1-1

PART NO.	QTY.	SIZE
K1-1	10	3/4" x 1/4"
K1-3	2	3/4" x 3/8"
K1-5	2	3/4" x 1/2"
K1-8	2	1/2" x 1/4"

Reducing Flare Tee

- Made in the USA 



TR2-446

PART NO.	QTY.	SIZE
TR2-446	5	1/4" x 1/4" x 3/8"
TR2-664	5	3/8" x 3/8" x 1/4"
TR2-668	2	3/8" x 3/8" x 1/2"
TR2-886	2	1/2" x 1/2" x 3/8"

Fiber Drum Adapter Seal Gasket

- Made in the USA 



K1-D

PART NO.	QTY.	SIZE
K1-D	10	1/2"
K1-E	10	3/4"

Reducing Nut



NRS4-43

PART NO.	QTY.	SIZE
NRS4-43	5	1/4" x 3/16"
NRS4-54	5	5/16" x 1/4"
NRS4-64	10	3/8" x 1/4"
NRS4-65	10	3/8" x 5/16"
NRS4-86	10	1/2" x 3/8"
NRS4-108	5	5/8" x 1/2"
NRS4-1210	2	3/4" x 5/8"

Flare Plug

- Made in the USA 



P2-12

PART NO.	QTY.	SIZE
P2-3	5	3/16"
P2-4	10	1/4"
P2-5	5	5/16"
P2-6	10	3/8"
P2-8	10	1/2"
P2-10	5	5/8"
P2-12	2	3/4"

Brass Fittings

JB INDUSTRIES

Flare x Male Pipe Adapter

- Made in the USA 

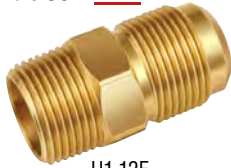

U1-12E

PART NO.	QTY.	SIZE
U1-3A	5	3/16" x 1/8"
U1-3B	5	3/16" x 1/4"
U1-4A	25	1/4" x 1/8"
U1-4B	25	1/4" x 1/4"
U1-4C	10	1/4" x 3/8"
U1-4D	10	1/4" x 1/2"
U1-5A	5	5/16" x 1/8"
U1-5B	5	5/16" x 1/4"
U1-5C	5	5/16" x 3/8"
U1-6A	10	3/8" x 1/8"
U1-6B	10	3/8" x 1/4"
U1-6C	10	3/8" x 3/8"
U1-6D	10	3/8" x 1/2"
U1-6E	5	3/8" x 3/4"
U1-8A	2	1/2" x 1/8"
U1-8B	5	1/2" x 1/4"
U1-8C	10	1/2" x 3/8"
U1-8D	10	1/2" x 1/2"
U1-8E	5	1/2" x 3/4"
U1-10B	5	5/8" x 1/4"
U1-10C	5	5/8" x 3/8"
U1-10D	10	5/8" x 1/2"
U1-10E	5	5/8" x 3/4"
U1-12C	2	3/4" x 3/8"
U1-12D	2	3/4" x 1/2"
U1-12E	2	3/4" x 3/4"
U1-14E	2	7/8" x 3/4"

Flare x Female Pipe Adapter

- Made in the USA 



U3-10E

PART NO.	QTY.	SIZE
U3-2A	5	1/8" x 1/8"
U3-3A	5	3/16" x 1/8"
U3-4A	10	1/4" x 1/8"
U3-4B	10	1/4" x 1/4"
U3-4C	5	1/4" x 3/8"
U3-5A	5	5/16" x 1/8"
U3-5B	5	5/16" x 1/4"
U3-6A	5	3/8" x 1/8"
U3-6B	5	3/8" x 1/4"
U3-6C	5	3/8" x 3/8"
U3-6D	5	3/8" x 1/2"
U3-8B	5	1/2" x 1/4"
U3-8C	5	1/2" x 3/8"
U3-8D	5	1/2" x 1/2"
U3-8E	2	1/2" x 3/4"
U3-10C	5	5/8" x 3/8"
U3-10D	5	5/8" x 1/2"
U3-10E	2	5/8" x 3/4"

Flare x Solder Adapter

- Furnished with copper gasket
- Made in the USA 



US3-1214

PART NO.	QTY.	SIZE
US3-44	10	1/4" x 1/4"
US3-45	5	1/4" x 5/16"
US3-46	5	1/4" x 3/8"
US3-64	5	3/8" x 1/4"
US3-65	5	3/8" x 5/16"
US3-66	10	3/8" x 3/8"
US3-68	5	3/8" x 1/2"
US3-610	5	3/8" x 5/8"
US3-86	2	1/2" x 3/8"
US3-88	5	1/2" x 1/2"
US3-810	2	1/2" x 5/8"
US3-108	2	5/8" x 1/2"
US3-1010	5	5/8" x 5/8"
US3-1012	2	5/8" x 3/4"
US3-1212	5	3/4" x 3/4"
US3-1214	2	3/4" x 7/8"

Flare x Male Pipe x Flare Tee

- Made in the USA 

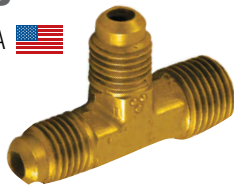

T3-4A

PART NO.	QTY.	SIZE
T3-4A	5	1/4" x 1/8" x 1/4"
T3-4B	5	1/4" x 1/4" x 1/4"
T3-5B	2	5/16" x 1/4" x 5/16"
T3-6B	5	3/8" x 1/4" x 3/8"
T3-6C	2	3/8" x 3/8" x 3/8"
T3-6D	2	3/8" x 1/2" x 3/8"
T3-8C	2	1/2" x 3/8" x 1/2"
T3-8D	2	1/2" x 1/2" x 1/2"
T3-10D	2	5/8" x 1/2" x 5/8"

Flare x Flare x Female Flare Tee

- Made in the USA 



T6-4

PART NO.	QTY.	SIZE
T6-4	2	1/4"

Finger Tight Flare Cap

- Made in the USA 



NFT5-4

PART NO.	QTY.	SIZE
NFT5-4-101	1000	1/4"
NFT5-6-101	500	3/8"

Flare Union

- Made in the USA 



U2-3

PART NO.	QTY.	SIZE
U2-2	5	1/8"
U2-3	5	3/16"
U2-4	25	1/4"
U2-5	10	5/16"
U2-6	25	3/8"
U2-8	10	1/2"
U2-10	10	5/8"
U2-12	2	3/4"
U2-14	2	7/8"

Reducing Flare Union

- Made in the USA 



UR2-54

PART NO.	QTY.	SIZE
UR2-43	5	1/4" x 3/16"
UR2-54	5	5/16" x 1/4"
UR2-64	10	3/8" x 1/4"
UR2-65	5	3/8" x 5/16"
UR2-84	5	1/2" x 1/4"
UR2-86	10	1/2" x 3/8"
UR2-106	5	5/8" x 3/8"
UR2-108	5	5/8" x 1/2"
UR2-128	2	3/4" x 1/2"
UR2-1210	2	3/4" x 5/8"

Female Flare x Flare Adapter

- Made in the USA 



UR3-1210

PART NO.	QTY.	SIZE
UR3-43	2	1/4" x 3/16"
UR3-46	10	1/4" x 3/8"
UR3-48	5	1/4" x 1/2"
UR3-64	20	3/8" x 1/4"
UR3-68	10	3/8" x 1/2"
UR3-84	10	1/2" x 1/4"
UR3-86	10	1/2" x 3/8"
UR3-810	10	1/2" x 5/8"
UR3-108	5	5/8" x 1/2"
UR3-1012	2	5/8" x 3/4"
UR3-1210	2	3/4" x 5/8"

Female Flare x Female Flare Connector

- Includes two copper gaskets
- Made in the USA 



U4-12

PART NO.	QTY.	SIZE
U4-4	10	1/4"
U4-6	10	3/8"
U4-8	2	1/2"
U4-10	2	5/8"
U4-12	2	3/4"

Female SAE Flare x Female Pipe Thread

- Made in the USA 



U6-4B

PART NO.	QTY.	SIZE
U6-4A	2	1/4" x 1/8"
U6-4B	2	1/4" x 1/4"

Swivel Female Flare Connector

- Made in the USA 



US4-10

PART NO.	QTY.	SIZE
US4-4	10	1/4"
US4-5	5	5/16"
US4-6	10	3/8"
US4-8	10	1/2"
US4-10	5	5/8"

Brass Fittings

JB INDUSTRIES

PRO TIPS

Brass Pipe Fittings

American-made forged brass pipe fittings manufactured from CA 377 alloy and threaded to Dry Seal Taper Pipe Standards to comply with SAE, ASA, ASME and MS Standards.

Forgings can be used to pressures of 5,000 psi depending on size, material and conditions.

- Vibration-resistant
- Low cost
- Easy assembly

Recommended for use with a compatible thread sealant and tightened 2-1/2 full turns past hand tight; over-tightening and dirt can damage fittings.

NOMINAL PIPE SIZE THREADS			
NOM. PIPE	THD. / IN.	NOM. PIPE	THD. / IN.
1/16"	27	2"	11.5
1/8"	27	2-1/2"	8
1/4"	18	3"	8
3/8"	18	3-1/2"	8
1/2"	14	4"	8
3/4"	14	5"	8
1"	11.5	6"	8
1-1/4"	11.5	8"	8
1-1/2"	11.5	—	—

Long Nipple

- Made in the USA 



113-D35

PART NO.	QTY.	SIZE
113-A15	5	1/8" x 1-1/2"
113-A2	5	1/8" x 2"
113-A25	5	1/8" x 2-1/2"
113-A3	5	1/8" x 3"
113-A35	5	1/8" x 3-1/2"
113-B15	5	1/4" x 1-1/2"
113-B2	5	1/4" x 2"
113-B25	5	1/4" x 2-1/2"
113-B3	5	1/4" x 3"
113-B35	5	1/4" x 3-1/2"
113-C15	5	3/8" x 1- 1/2"
113-C2	5	3/8" x 2"
113-C25	5	3/8" x 2-1/2"
113-C3	5	3/8" x 3"
113-D15	5	1/2" x 1-1/2"
113-D2	5	1/2" x 2"
113-D25	5	1/2" x 2-1/2"
113-D3	2	1/2" x 3"
113-D35	2	1/2" x 3-1/2"

Hex Nipple (U10)

- Made in the USA 



122-E

PART NO.	QTY.	SIZE
122-A	5	1/8"
122-B	10	1/4"
122-C	5	3/8"
122-D	5	1/2"
122-E	5	3/4"

Close Nipple

- Made in the USA 



112-B

PART NO.	QTY.	SIZE
112-A	5	1/8"
112-B	10	1/4"
112-C	5	3/8"
112-D	5	1/2"
112-E	5	3/4"

Extra Long Flare x Male Pipe Adapter

- Made in the USA 



UX1-4B

PART NO.	QTY.	SIZE
UX1-4A	2	1/4" x 1/8"
UX1-4B	5	1/4" x 1/4"

Extra Long Flare Union

- Made in the USA 



UX2-4

PART NO.	QTY.	SIZE
UX2-4	5	1/4"

Female SAE Flare x Male Pipe Thread

- Includes copper seal gasket
- Made in the USA 



U5-4B

PART NO.	QTY.	SIZE
U5-4A	5	1/4" x 1/8"
U5-4B	10	1/4" x 1/4"
U5-6B	5	3/8" x 1/4"
U5-8C	2	1/2" x 3/8"
U5-8D	2	1/2" x 1/2"

EII

- Made in the USA 



100-E

PART NO.	QTY.	SIZE
100-A	5	1/8"
100-B	5	1/4"
100-C	5	3/8"
100-D	2	1/2"
100-E	2	3/4"

Street EII

- Made in the USA 



116-D

PART NO.	QTY.	SIZE
116-A	5	1/8" Forged
116-B	5	1/4" Forged
116-C	5	3/8" Forged
116-D	2	1/2" Forged

Coupling PC

- Made in the USA 



103-E

PART NO.	QTY.	SIZE
103-A	5	1/8"
103-B	10	1/4"
103-C	5	3/8"
103-D	5	1/2"
103-E	5	3/4"

Tee

- Made in the USA 



101-E

PART NO.	QTY.	SIZE
101-A	5	1/8"
101-B	10	1/4"
101-C	5	3/8"
101-D	2	1/2"
101-E	2	3/4"

Compression Break-Off Sleeve Pilot Nut

- Made in the USA 



81LB-4

PART NO.	QTY.	SIZE
81LB-4	10	1/4"

Hex Head Plug (P3)

- Made in the USA 



121-C

PART NO.	QTY.	SIZE
121-A	10	1/8"
121-B	10	1/4"
121-C	5	3/8"
121-D	5	1/2"
121-E	5	3/4"
121-F	2	1"

One-way Check Valve

NEW

- 1/4" x 1/4" Flare
- Self centering seal design
- O-ring soft seat / metal back-up seal
- Zero leakage
- 1/3 psi cracking pressure
- Maximum pressure 1500 psig
- Temperature -40 to 300°F
- Made in the USA 



PART NO.	QTY.	SIZE
U2-4CHK	1	1/4" x 1/4" Flare Valve

Hex Brushing (R1)

- Made in the USA 



110-EA

PART NO.	QTY.	SIZE
110-BA	10	1/4" x 1/8"
110-CA	5	3/8" x 1/8"
110-CB	10	3/8" x 1/4"
110-DA	5	1/2" x 1/8"
110-DB	10	1/2" x 1/4"
110-DC	10	1/2" x 3/8"
110-EA	2	3/4" x 1/8"
110-EB	5	3/4" x 1/4"
110-EC	5	3/4" x 3/8"
110-ED	5	3/4" x 1/2"
110-FD	2	1" x 1/2"
110-FE	2	1" x 3/4"

Full Flow Refrigeration Ball Valves

Large port design that provides a minimum pressure drop with straight through flow. Copper end fittings reduce installation time without disturbing valve. Two types of ball valves to suit your needs—traditional refrigerant ball valves with brass actuators and a working pressure rating of 500 psi and E-Line ball valves featuring stainless steel actuators and a working pressure rating of 700 psi.

Fig 1 – Measurement Chart Key (Fig 1:1 - Fig 1:6 charts page 59)

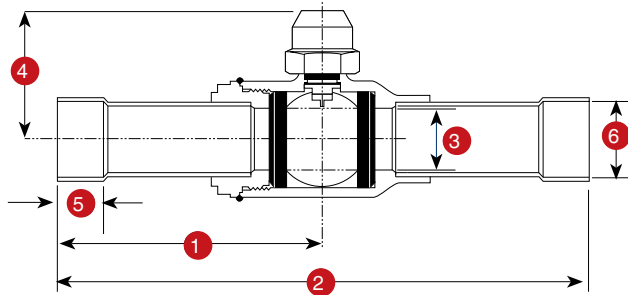

Fig 2 – Ball Valve Operation (7-8)

7 Quarter-turn mechanical stop. Positive open and closed positions. Packing gland adjusting nut.

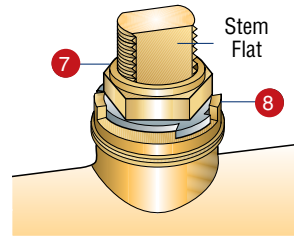
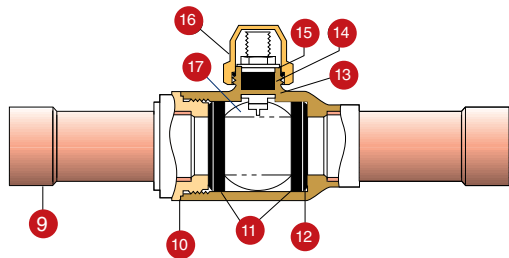

Fig 3 - Anatomy of a Ball Valve (9-17)



- 9 Copper tube extensions
- 10 Hermetic welded and brazed joints
- 11 Reinforced Teflon seats
- 12 One-piece forged brass body
- 13 Bearing washer
- 14 Changeable reinforced PTFE stem packing
- 15 Packing gland
- 16 Stem cap assembly with neoprene seal
- 17 Chromium plated ball with vented valve

Shutoff Ball Valves

- Straight through flow design has no restriction
- Quarter-turn and valve is fully open or closed
- Made in the USA

Needle Ball Valves

- Resistant to gasoline, oils and water
- Metal-to-metal seating provides ease in shutoff
- Working pressures of 105 psi

E-Line Actuator Retrofit Caps

For the replacement of existing caps on installed valves. Secures the cap assembly to valve neck, allowing the center post to easily turn for on/off operation. Utilizes a Teflon® o-ring stem seal and base seal to assure a positive seal offsetting any stem packing leak.



V34900

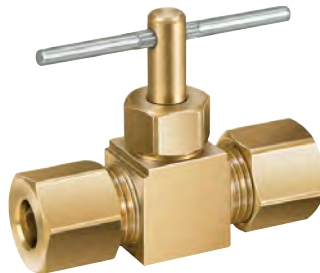

NV62-4



V34-RC33

PART NO.	DESCRIPTION
V34900	1/8" Female NPT x 1/8" Female NPT
V34901	1/4" SAE x 1/8" NPT
V34905	1/4" SAE x 1/4" NPT
V34910	3/8" Female NPT x 3/8" Female NPT

PART NO.	DESCRIPTION
NV62-4	1/4" COMP x 1/4" COMP

PART NO.	DESCRIPTION
V34-RC33	2-1/8" - 3-1/8" Ball valve retrofit cap
V34-RC19	1-3/8" - 1-5/8" Ball valve retrofit cap
V34-RC12	3/4" - 1-1/8" Ball valve retrofit cap
V34-RC4	1/4" - 5/8" Ball valve retrofit cap

Refrigerant Ball Valves

- Pressure rated to 500 psi
- Bolted or screwed bonnets or flanges
- Up to +500°F working temperature at 0 psi
- Up to +300°F working temperature at 500 psi
- Registered to ISO 9001
- UL Listed 57R7
- Made in the USA 



V34202



V34400



E-Line Actuators

- Pressure rated to 700 psi
- Bolted or screwed bonnets or flanges
- UL Listed 32DC



V34307



V34507



PART NO. WITHOUT PORT	PART NO. WITH PORT	ID FIG 1: 6	FIG 1: 1	FIG 1: 2	FIG 1: 3	FIG 1: 4	FIG 1: 5
V34200	V34400	3/8"	3.18"	6.09"	0.30"	1.55"	3/8"
V34201	V34401	1/2"	3.18"	6.09"	0.45"	1.55"	3/8"
V34202	V34402	5/8"	3.43"	6.59"	0.50"	1.55"	1/2"
V34203	—	3/4"	3.45"	7.27"	0.69"	1.89"	3/4"
V34204	V34404	7/8"	3.69"	7.07"	0.75"	1.83"	3/4"
V34206	V34406	1-1/8"	4.20"	8"	1"	2.01"	2-9/32"
V34207	V34407	1-3/8"	4.54"	8.63"	1.25"	2.61"	3-1/32"
V34208	V34408	1-5/8"	4.47"	8.85"	1.50"	2.79"	1-3/32"
V34209	V34409	2-1/8"	4.84"	9.59"	2"	3.17"	1-11/32"
V34210	—	2-5/8"	5"	10"	2.43"	3.90"	1-31/64"
V34211	—	3-1/8"	7"	14"	2.50"	3.90"	1-43/64"

PART NO. WITHOUT PORT	PART NO. WITH PORT	ID FIG 1: 6	FIG 1: 1	FIG 1: 2	FIG 1: 3	FIG 1: 4	FIG 1: 5
V34350	V34525	1/4"	3.25"	6.5"	0.50"	1.51"	3/8"
V34300	V34500	3/8"	3.18"	6.09"	0.30"	1.55"	3/8"
V34301	V34501	1/2"	3.18"	6.09"	0.45"	1.55"	3/8"
V34302	V34502	5/8"	3.43"	6.59"	0.50"	1.55"	1/2"
V34303	V34503	3/4"	3.45"	7.27"	0.69"	1.89"	3/4"
V34304	V34504	7/8"	3.69"	7.07"	0.75"	1.83"	3/4"
V34306	V34506	1-1/8"	4.20"	8"	1"	2.01"	2-9/32"
V34307	V34507	1-3/8"	4.54"	8.63"	1.25"	2.61"	3-1/32"
V34308	V34508	1-5/8"	4.47"	8.85"	1.50"	2.79"	1-3/32"
V34309	V34509	2-1/8"	4.84"	9.59"	2"	3.17"	1-11/32"
V34310	V34510	2-5/8"	5"	10"	2.43"	3.90"	1-31/64"
V34311	V34511	3-1/8"	7"	14"	2.50"	3.90"	1-43/64"



JUST BETTER TOOLS for HVACR Industry Professionals

High quality JUST BETTER TOOLS feature superior craftsmanship for dependable performance, reliability and durability you can count on—from the brand you trust.

The full line of heavy-duty, high-performance tools and accessories from JB Industries ensures your tool kit has everything you need to get the job done.

Large and small planogram options available for quick and easy displays. Tool literature can be downloaded at jbind.com. Contact customer service for more information.

JUST BETTER SINCE 1967—JB Industries is dedicated to providing quality and innovative tools to satisfy customer needs and serve the HVACR industry.

Mini Tube Cutters

- For use with copper
- Large knurled knob for fatigue-free pressure control



RT70401



RT70015

PART NO.	QTY.	DESCRIPTION
RT70401	1	Copper Mini-Cut Pro 1/8" to 5/8" OD
RT70402	1	Copper Mini-Pro 1/4" to 7/8" OD
RT70105	1	Copper Mini-Pro 1/8" to 7/8" OD
RT70015	1	Copper Mini-Max 1/8" to 1-1/8" OD
RT70017B	2	Replacement cutter wheel
RT70017D	5	Replacement cutter wheel
RT70041	1	Replacement axle screw/pin

Professional Tube Cutters

- For use with copper, brass and aluminum
- Retractable deburrer blade and a spare cutter wheel in the handle
- Easy-to-turn knob for quick adjustment



RT70027



RT70029

PART NO.	QTY.	DESCRIPTION
RT70027	1	1/4" to 1-3/8" OD copper, brass and aluminum pipe
RT70029	1	1/4" to 1-5/8" OD copper, brass and aluminum pipe
RT21652	1	Replacement deburring blade
RT21652B	10	Replacement deburring blades
RT70017B	2	Replacement cutter wheel
RT70017D	5	Replacement cutter wheel
RT70056D	5	Replacement cutter wheel for stainless steel

Rotrac Plus Tube Cutters

- For use with copper
- Smooth-running telescopic action for consistent working radius
- Protected screw spindle to shield against dirt and jamming
- Includes three spare cutter wheels; storage in handle



RT70020



RT70021

PART NO.	QTY.	DESCRIPTION
RT70020	1	Copper tube 1/8" to 1-1/8" OD
RT70021	1	Copper tube 1/4" to 1-5/8" OD
RT70007B	2	Replacement cutter wheel
RT70007X	10	Replacement cutter wheel
RT99016	1	Replacement clip and axle

Ratchet Tube Cutter

- For use with copper, brass, aluminum, thin-walled steel and plastic coated tubes
- Telescopic guide; automatic spring-driven withdrawal
- Retractable internal deburring tool
- Spare cutter wheel in handle



RT70030

PART NO.	QTY.	DESCRIPTION
RT70030	1	1/4" to 2-5/8" OD
RT70142	1	2" to 5" OD
RT70017B	2	RT70030 Replacement wheel
RT70017D	5	RT70030 Replacement wheel
RT70057D	2	RT70142 Replacement wheel
RT21652	1	Replacement deburring blade
RT21652B	10	Replacement deburring blades
RT75007	1	Replacement pin and axle

Pipe Shears

- For use with PVC, PP, PE, PEX, PB, CPVC and PVDF
- Quick-release lever
- Double-sided stainless steel blade with v-shaped edges
- Locking lever



RT52000

PART NO.	QTY.	DESCRIPTION
RT52000	1	Max. OD 1-5/8", Schedule 40 PVC 1-1/4"
RT52010	1	Max. OD 2", Schedule 40 PVC 1-1/2"
RT52011	1	Replacement blade for RT52010
RT52030	1	ROCUT® 63TC, Max. OD 2-1/2"
RT52042	1	Replacement blade for RT52000

SM-18 Solenoid Valve Operating Magnet

- Designed to convert electrically operated solenoid valves into hand-operated valves to enable service engineers to operate valves manually
- Operates by magnetically lifting the stem assembly and plunger to actuate the valve during service
- Use this solenoid service magnet to test, troubleshoot or manually activate and control a direct connected or pilot operated 2-way solenoid, 3-way reclaim or 4-way reversing valve
- Use to hold a solenoid valve open during recovery and evacuation
- Use in place of the powerhead on a hot water oil shutoff valve to eliminate the need to wait for the delay on open
- Use to temporarily replace faulty coil to open solenoid valve
- Use to turn the power on or replace faulty solenoid
- Handy pocket size
- Easy to use and time-saving
- Permanent magnet molded in ABS plastic
- Safe design fits all makes of solenoid valves
- 18mm

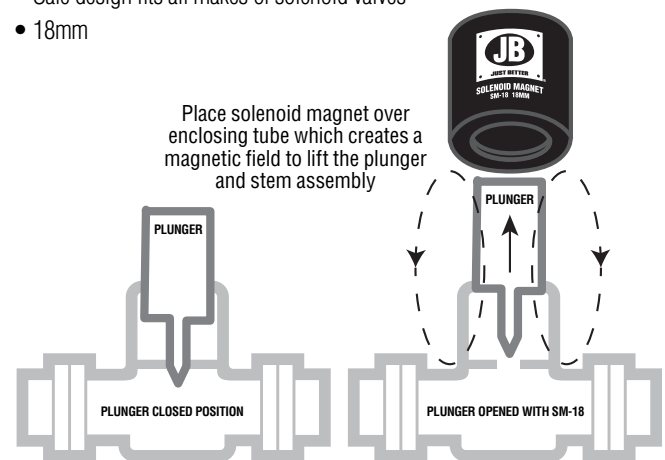

PART NO.	DESCRIPTION
SM-18	18mm Solenoid Magnet

Aluminum Pipe Wrench



RT70160

PART NO.	DESCRIPTION
RT70159	10" Aluminum pipe wrench
RT70160	14" Aluminum pipe wrench
RT70161	18" Aluminum pipe wrench

Slim Profile Adjustable Wrench

- Slim profile; Extra-wide jaw opening
- Designed for TXV/TEV valves, motor mounts, gas lines, pumps and more
- 40% slimmer jaw allows for greater capacity and range of motion in tight spaces
- Extremely strong and durable for years of use
- Comfortable cushion grip handle



PART NO.	DESCRIPTION
RT70170	6" Adjustable wrench
RT70171	8" Adjustable wrench

Water Pump Pliers

- Ideal for hard to reach places
- Heavy-duty, slip-proof with self-clamping jaws



RT70522

PART NO.	DESCRIPTION
RT70521	7" Pliers Max. 1" OD
RT70522	10" Pliers Max. 1-1/4" OD
RT70523	12" Pliers Max. 1-1/4" OD

Rolock Pliers

- Professional-grade jaw locking system
- Groove opening positions up to 2-1/3"



RT70532

PART NO.	DESCRIPTION
RT70531	7" Rolock
RT70532	10" Rolock

Machine Grooved Joint Pliers



RT70534

PART NO.	SIZE
RT70534	12" Machine grooved joint pliers

Service Wrenches

NEW

- Double-end reversible
- Available in offset, hex and square ends
- Made in the USA 



T21128U

PART NO.	DESCRIPTION
T21124U	3/16", 1/4" square x 1/2", 9/16" hex port
T21125U	3/8" Square end and 1/2" square end
T21126U	Offset 1/4", 3/16" x 3/8", 5/16"
T21127U	1/4", 3/16" x 3/8", 5/16" on other end
T21128U	1/8" End Sporlan Wrench

Minibend® Tube Bender

- For use with soft copper, brass, aluminum and precision steel
- Precise bending up to 180° 1/4", 5/16" and 3/8" OD



PART NO.	DESCRIPTION
RT25151	Minibend® tube bender

Torque Wrench Kit

- Torque range of 7.375 - 59.004 lb-ft or 10-80 Nm with a 1/2" DR ratchet head



PART NO.	DESCRIPTION
TRQ-1080	Torque wrench kit; six spanner heads: 17, 22, 24, 26, 27, 29mm

Hand Tube Bender

- For use with soft copper, aluminum and light grade stainless steel tubing
- Universal tool for bending of 1/2", 5/8", 3/4" and 7/8" OD



PART NO.	DESCRIPTION
RT90614	Hand tube bender

Imperial Spanner Heads

- For use with TRQ1080 torque wrench



PART NO.	DESCRIPTION
TRQ-IMP	Imperial spanner heads; four spanner heads: 5/8", 13/16", 15/16", 1-1/8"

Standard Tube Bender Pro

- For use with 1/2" and 3/4" soft copper, aluminum and precision steel
- Precise bending radius up to 180°
- Clamping mechanism



RT25140

PART NO.	DESCRIPTION
RT25140	1/4" OD radius (0.71")
RT25131	5/16" OD radius (0.95")
RT25913	Tube Bender Pro 1/2" OD radius
RT25914	Tube Bender Pro 3/4" OD radius
RT25142	1/2" OD radius
RT25136	5/8" OD radius (2.28")

Spring Tube Benders

- For use with soft copper, aluminum, brass and steel
- Made in the USA 



SPRING TUBE BENDER SETS		
PART NO.	DESCRIPTION	
BS-55	1/4", 5/16", 3/8", 1/2", 5/8" in pouch	
BS-77	1/4", 5/16", 3/8", 7/16", 1/2", 5/8", 3/4", 7/8" in pouch	
SINGLE SPRING TUBE BENDERS		
PART NO.	TUBE OD	NOM
BS-4	1/4"	1/8"
BS-5	5/16"	—
BS-6	3/8"	1/4"
BS-7	7/16"	—
BS-8	1/2"	3/8"
BS-10	5/8"	1/2"
BS-12	3/4"	5/8"
BS-14	7/8"	3/4"

Ratcheting Flare Tool



T20195

PART NO.	DESCRIPTION
T20195	3/16", 1/4", 5/16", 3/8", 7/16" OD (Nom: 1/8", 1/4", 3/8" and 1/2")
T20203	5/8", 3/4", 7/8", and 1-1/8" OD
T20500	3/16", 1/4", 5/16", 3/8", 1/2", 5/8" OD

Maxi Tube Bender Set

- For use on copper and soft aluminum 3/8", 1/2", 5/8", 3/4" and 7/8" OD
- Smooth-running feed lever ideal in tight spaces
- Single-handed operation
- Quick-release side lever
- Includes tool, bending support, bending formers and case



PART NO.	DESCRIPTION
RT23022	Maxi tube bender set for use on copper and soft aluminum 3/8", 1/2", 5/8", 3/4" and 7/8" OD

45° Flare Tool

- Made in the USA 



PART NO.	DESCRIPTION
RT26036	45° Flare tool; flares 3/16", 1/4", 5/16", 3/8", 1/2", and 5/8"

Ratcheting Flare Tool



PART NO.	DESCRIPTION
T30600	Flares: 3/16", 1/4", 5/16", 3/8", 1/2", 5/8", 3/4" OD

Flare Tool



PART NO.	DESCRIPTION
RT222601	Flare tool; adjustable from 3/16" to 5/8" OD

45° Flare Tool



PART NO.	DESCRIPTION
RT222402	Flares: 1/8", 3/16", 1/4", 5/16", 3/8", 1/2", 5/8", 3/4" OD

45° Flare/Swage

- Heavy-duty, wide range bar type flaring tool
- Centering yoke with hardened chrome plated and swivel-type cone



PART NO.	DESCRIPTION
T20275	Flare: 1/8", 3/16", 1/4", 5/16", 3/8", 7/16", 3/4"
	Nominal Flare: 1/8", 1/4", 1/2", 5/8"
	Swage: 3/16", 1/4", 5/16", 3/8", 1/2", 5/8", 3/4"
	Nominal Swage: 1/8", 1/4", 3/8", 1/2", 5/8"

Hex Key Adapter

- For use with 3/16" and 5/16" hex valves
- Made in the USA



PART NO.	DESCRIPTION
T2-HKA	Hex key adapter

Tube Expander Kit

- High strength, forged aluminum body for lower weight and easy handling
- Automatic retractable pin guide



PART NO.	DESCRIPTION
RT12318	Tube expander kit; riveted expander heads in 3/8", 1/2", 5/8", 3/4", 7/8", 1-1/8", internal/external deburring tool, steel case

Steel Strap

- Zinc plated with alternating 1/8" and 1/4" nail and bolt holes
- Made in the USA



PS-10

PART NO.	DESCRIPTION
PS-10	10' (3m) Steel strap
PS-25	25' (7.6m) Steel strap
PS-50	50' (15m) Steel strap
PS-100	100' (30.5m) Steel strap

Metal Flare Size Gauge

- Measures all flares to provide superior seal tightness against flare fittings—a must for every toolbox
- Made in the USA



PART NO.	DESCRIPTION
T30600-G	Metal Flare Size Gauge; 1/4", 3/8", 1/2", 5/8", 3/4" SAE (6.4mm, 9.5mm, 12.7mm, 15.9mm, 19.1mm)

Oil Transfer Pump

- Pumps oil into the system without shutting down for charging
- Universal tapered rubber adapter fits all 1, 2.5 and 5-gallon containers
- Works against 200 psi of pressure
- Compatible with all oil types
- Pumps 2.6 ounces (78ml) per stroke



PART NO.	DESCRIPTION
T30251	Oil transfer pump

Just Better Tools

JB INDUSTRIES

Swaging Kit

- For use with copper, brass, aluminum and steel tubes
- Includes flaring tool, 45° cone, expander pin, internal/external deburrer, tube cutter and plastic case



PART NO.	DESCRIPTION
RT26715	Swaging kit; 3/16", 1/4", 5/16", 3/8", 1/2", 5/8"

Single Size Swage Tools

- Made in the USA



PART NO.	TUBE OD	NOM
T21002	1/8"	—
T21003	3/16"	—
T21004	1/4"	1/8"
T21005	5/16"	—
T21006	3/8"	1/4"
T21007	7/16"	—
T21008	1/2"	3/8"
T21010	5/8"	1/2"
T21012	3/4"	5/8"
T21014	7/8"	3/4"
T21018	1-1/8"	1"
T21024	Packaged set: 1/4", 3/8", 1/2" and 5/8"	Packaged set: 1/8", 1/4", 3/8" and 1/2"

Multi-Swage

- Made in the USA



PART NO.	DESCRIPTION
T21000	Multi-swage Tool Set; 3/16", 1/4", 5/16", 3/8", 7/16", 1/2", 5/8", 3/4", 7/8" OD. 1/8", 1/4", 3/8", 1/2", 5/8", 3/4" Nominal

Multi-Swage

- Made in the USA



PART NO.	DESCRIPTION
T20095	Multi-swage Tool; 1/4", 5/16", 3/8", 7/16", 1/2", 5/8" OD

Hex Key Sets

- Made in the USA



PART NO.	DESCRIPTION
T30605	Metric (2-8mm) and Imperial (5/64" - 1/4") hex key sets

Braze-Rite Adapter

- For use with copper tube
- Stepped nitrogen purging adapter for HVACR pipe
- Made in the USA 



PART NO.	DESCRIPTION
BRZ1000	Braze-Rite Adapter; ACR copper tube size: 1-1/8", 7/8", 3/4", 5/8", 1/2", 3/8"

Pinch-Off Tool

- Temporarily closes off line during repairs
- Quick-release trigger and rounded jaws



PART NO.	DESCRIPTION
T21294	Pinch-off tool; For 1/8" to 5/8" OD (1/8" to 1/2" Nominal)

O-ring/Gasket Removal Tool

NEW



PART NO.	DESCRIPTION
A10974	O-ring/Gasket Removal Tool

Deburring Tools

- For copper and plastic tube



RT11006



RT70075



RT21655



RT21660

PART NO.	QTY.	DESCRIPTION
RT11006	1	Copper and stainless steel internal/external reamer 1/4" to 1-1/2" OD
RT70075	1	Copper and stainless steel internal/external reamer 1/8" to 2" OD
RT21660	1	Deburring tool (blade non-replaceable)
RT21655	1	Deburring tool
RT21652	1	Replacement deburring blade
RT21652B	10	Replacement deburring blades

Fin Straighteners



T20351



T20352



T20353

PART NO.	DESCRIPTION
T20351	For 8, 9, 10, 12, 14 and 15 spacings per inch
T20352	Stainless steel fin straightener
T20353	Stainless steel fin straightener with large, easy-to-grip handle

Capillary Tubing

JB INDUSTRIES

Capillary Tubing

- Cut from 100' (30.5m) sealed and dehydrated tube
- Boxed with conversion and application charts
- Available in cartons of 10; add suffix -101 to part number
- Made in the USA 

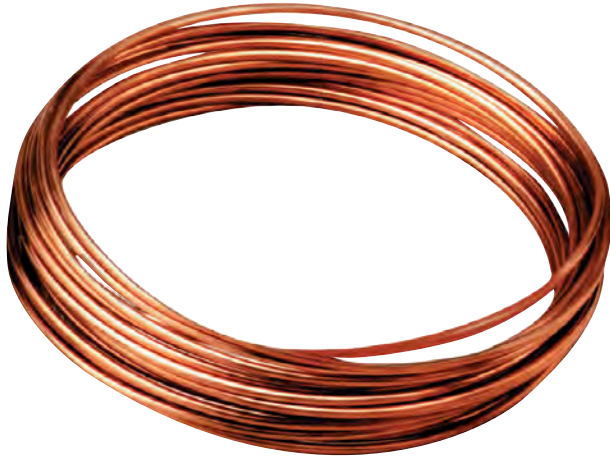

TC-26-16

SHORT COIL	100' COILS	DESCRIPTION
TC-26-16	TC-26-100	0.026 ID x 0.072 OD x 16'
TC-31-12	TC-31-100	0.031 ID x 0.083 OD x 12'
TC-36-12	TC-36-100	0.036 ID x 0.087 OD x 12'
TC-42-12	TC-42-100	0.042 ID x 0.093 OD x 12'
TC-44-12	TC-44-100	0.044 ID x 0.109 OD x 12'
TC-49-11	TC-49-100	0.049 ID x 0.099 OD x 11'
TC-50-11	TC-50-100	0.050 ID x 0.114 OD x 11'
TC-54-11	TC-54-100	0.054 ID x 0.106 OD x 11'
TC-55-11	TC-55-100	0.055 ID x 0.125 OD x 11'
TC-59-10	TC-59-100	0.059 ID x 0.112 OD x 10'
TC-64-10	TC-64-100	0.064 ID x 0.125 OD x 10'
TC-70-12	TC-70-100	0.070 ID x 0.125 OD x 12'
TC-75-9	TC-75-100	0.075 ID x 0.125 OD x 9'
TC-80-10	TC-80-100	0.080 ID x 0.145 OD x 10'
TC-85-9	TC-85-100	0.085 ID x 0.145 OD x 9'
TC-90-7	TC-90-100	0.090 ID x 0.145 OD x 7'
TC-100-10	TC-100-100	0.100 ID x 0.156 OD x 10'

Cap Tube Gauge and File

- Specially designed file to cut and open tubes
- ID sizes 0.026 to 0.090 units and OD sizes 0.072" to 7/16" (5 to 12mm)
- Made in the USA 

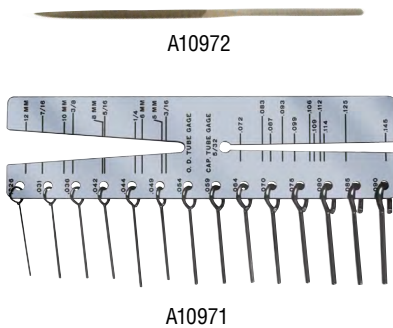

A10972

A10971

PART NO.	DESCRIPTION
A10971	Cap tube gauge and file in pouch
A10972	Cap tube file

Cap Tube Cutting Tool

- Sturdy cap tube cutter—no collapsing of the tube, no chips and clean cuts



PART NO.	DESCRIPTION
A10973	Cap tube cutting tool

Acid Brushes

- Ideal for thread sealant, flux and paste solders



PART NO.	DESCRIPTION
C33804	1/4" Flux brush (12 pack)
C33808	1/2" Flux brush (10 pack)
C33808-CTN	1/2" Flux brush (144 bulk)

Capillary Tubing Length Conversion Chart

It is recommended that conversions be made using factors within the unshaded area.

1. Locate recommended Cap Tube ID in left hand column
2. Read across and find conversion factor under Cap Tube ID Size
3. Multiply the given length of the recommended cap tube by the conversion factor
4. The resulting length (min. 5ft/max.16ft) of copper cap tube will give the same flow characteristics as the original recommended cap tube

Example:

Recommended cap tube: 9'-.040 ID

Locate .040 in left hand column. Read across the recommended conversion:

Part No. TC-36 = .62, Part No. TC-42 = 1.25

Multiply the recommended cap tube length of 9' by the conversion factor:

Part No. TC-36 = 9' x .62 = 5.58"

Part No. TC-42 = 9' x 1.25 = 11.25"

Either of these cap tubes will give the same results as the original cap tube

CAP TUBE ID	PART NO.																
	TC-26 (.026)	TC-31 (.031)	TC-36 (.036)	TC-42 (.042)	TC-44 (.044)	TC-49 (.049)	TC-50 (.050)	TC-54 (.054)	TC-55 (.055)	TC-59 (.059)	TC-64 (.064)	TC-70 (.070)	TC-75 (.075)	TC-80 (.080)	TC-85 (.085)	TC-90 (.090)	TC-100 (.100)
.024	1.44																
.025	1.20																
.026	1.00	2.24															
.028	.72	1.59															
.030	.52	1.16															
.031	.45	1.00	2.00														
.032		.86	1.75														
.033		.75	1.54														
.034		.65	1.35														
.035		.58	1.16	2.31													
.036		.50	1.00	2.10													
.037		.45	.90	1.79	2.22												
.038		.39	.80	1.59	1.92												
.039		.35	.71	1.41	1.75												
.040		.31	.62	1.25	1.55	2.51											
.041		.28	.56	1.12	1.38	2.26	2.50										
.042		.25	.50	1.00	1.24	2.03	2.23										
.043		.23	.45	.87	1.11	1.83	1.98										
.044		.20	.39	.81	1.00	1.62	1.79										
.045			.35	.73	.90	1.47	1.60	2.32									
.046			.32	.67	.82	1.34	1.47	2.08	2.27								
.047				.59	.74	1.20	1.31	1.89	2.06								
.048				.54	.67	1.10	1.20	1.72	1.87								
.049				.49	.61	1.00	1.09	1.55	1.69								
.050				.45	.56	.91	1.00	1.43	1.56	2.14							
.051				.41	.51	.84	.93	1.31	1.44	1.96							
.052					.47	.76	.85	1.19	1.32	1.78							
.053					.43	.69	.78	1.09	1.20	1.64							
.054					.39	.65	.70	1.00	1.09	1.52	2.18						
.055					.36	.59	.64	.92	1.00	1.38	2.00						
.056						.54	.60	.85	.94	1.27	1.85						
.057						.50	.55	.79	.87	1.17	1.72						
.058						.46	.51	.73	.80	1.07	1.56						
.059						.42	.47	.67	.73	1.00	1.44	2.18					
.060						.39	.43	.62	.67	.93	1.33	2.04					
.064							.32	.47	.50	.69	1.00	1.50	2.07				
.070								.30	.33	.46	.67	1.00	1.37	1.84			
.075											.48	.73	1.00	1.37	1.75		
.080												.54	.74	1.00	1.32	1.71	
.085													.57	.76	1.00	1.29	
.090													.43	.62	.76	1.00	1.62
.095														.46	.60	.79	1.27
.100															.48	.62	1.00
.105																.49	.80
.110																	.65
.115																	.53
.120																	.43

R134a Automotive Couplers

- Quick connect/disconnect valve actuation without refrigerant venting
- Safety sleeve holds coupler securely to service port
- Color-coded knobs
- Made in the USA 



AC-13430



AC-15530

R134a Automotive Quick Adapter

- Retrofit existing SAE flare fitting for R134a auto service
- Made in the USA 



QC-13445-134a



QC-S4A-134a

PART NO.	DESCRIPTION
AC-13430	High side 90° snap coupler x 14 mm
AC-13435	Low side 90° snap coupler x 14 mm
AC-15530	High side 90° snap coupler x 1/4" SAE
AC-15535	Low side 90° snap coupler x 1/4" SAE

PART NO.	QC GASKET	DESCRIPTION
QC-S4A-134A	P509	1/4" QC x 1/2" male ACME thread
QC-13445-134A	P510	1/2" ACME QC x 1/4" male flare

1/2" ACME Thread Half Union

- Made in the USA 

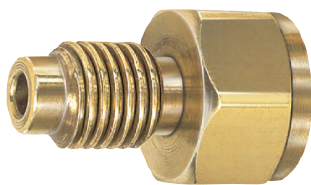

AF-13457

PART NO.	DESCRIPTION
AF-13450	1/8" NPTF
AF-13451	1/4" NPTF
AF-13452	3/8" NPTF
AF-13455	1/4" Female SAE
AF-13457	3/8" Female SAE

Automotive Oil Tap Tube

- Reduces motor burnout by simplifying acid tests
- Can be left in place for future tests and oil changes
- Made in the USA 



PART NO.	DESCRIPTION
A33600	Automotive oil tap tube

1/2" ACME Service Valve

- 1/2" ACME x 1/8" NPTF with cap
- Made in the USA 



PART NO.	DESCRIPTION
AF-13550	1/2" Acme service valve

Cool Gel™ Heat Barrier Spray

- Prevents heat damage during soldering, brazing and welding
- Safe, non-toxic and odorless
- Made in the USA 



PART NO.	QTY.	DESCRIPTION
11509	12	Cool Gel™ 1 quart bottles

Bloc-It® Heat Absorbing Paste

- Protects against damage caused by heat from soldering brazing and welding
- Made in the USA 



PART NO.	QTY.	DESCRIPTION
11511	24	Bloc-It® 10oz tubes

Heat-Seal Stik® Premixed Epoxy Sealer

- For use on aluminum, copper, metals, glass and ceramics
- Works on R410A based systems
- Cures in 90 seconds
- Sealing temperature to 350° F (177°C); pressures to 450 psi (31 bar)
- Made in the USA 



PART NO.	QTY.	DESCRIPTION
11575	12	Heat-Seal Stik® 3/8oz sticks

Pipetite-Stik®

- For use with water, steam, air, natural gas and LP gas
- Non-toxic and lead-free
- Sealing temperature to 350°F (177°C)
- Pressures to 2,000 psi (136 bar) for liquids and 350 psi (24 bar) for gases
- Made in the USA 



PART NO.	QTY.	DESCRIPTION
11175	12	Pipetite-Stik® 1.25oz sticks
19571	12	Epoxy-Stik® 4oz sticks

Slic-Tite® Paste with PTFE

- Seals water, air, steam, natural gas, LP gas, refrigerants, ammonia, gasoline and oil
- For use with metal, PVC, CPVC and ABS plastic threads
- Sealing temperature -50°F to 500° F (-46°C to 260°C)
- Pressures 3,000 psi (204 bar) for gas, 10,000 psi (680 bar) for liquid.
- Made in the USA 



PART NO.	QTY.	DESCRIPTION
42019	12	Slic-Tite® 8oz bottles

Valve Action™ Paint Marker

- Lead-free, weather, water, UV-resistant paint marker dries in three minutes
- For use on metal, wood, glass, plastic, rubber, cardboard and paper
- Marking range -50°F to 150°F (-46°C to 66°C)
- Made in the USA 



PART NO.	QTY.	DESCRIPTION
96820	12	White Valve Action™ paint marker
96822	12	Red Valve Action™ paint marker
96823	12	Black Valve Action™ paint marker

LIMITED WARRANTY

All JB Industries, Inc. tools are warrantied against defects in materials and workmanship for a period of 12 months from the date of purchase with the following exceptions:

- **Leak Detectors (LD-5000, LD-3000, LDC-4000):** 2 years
- **ATLAS® Scales:**
 - DS-250, DS-20000 2 years
- **CO2 Manifold (30744):** 3 years
- **Recovery:**
 - F6-DP 3 years OTC
 - F6-BOOST 1 year OTC
- **Vacuum Pumps:**
 - PLATINUM® 2 years OTC
 - PLATINUM® BEAST 2 years OTC
 - PLATINUM® FLEX 1 year OTC
 - ELIMINATOR® 2 years OTC
 - Rebuilt Vacuum Pumps 6 months
 - Out of Warranty Vacuum Pump Repairs 90 days

JB tools are guaranteed when used in accordance with guidelines and recommendations. Warranty is limited to the repair, replacement or credit at invoice price, (our option) of tools which, in our opinion, are defective due to workmanship and/or materials. In no instance will we allow charges for labor, expense, or consequential damage. Repairs performed on items out of warranty will be invoiced on a nominal basis; contact wholesaler for details. Additional tool warranty information available online at www.jbind.com.

NO WARRANTY OF MERCHANTABILITY OR FITNESS FOR ANY PARTICULAR PURPOSE. Technical information, recommendations and advice as to properties and usages of materials, design, installation and use of tools, engineering and other matters are provided as an accommodation and are intended only as suggestions. Although they are believed to be accurate, based on JB's knowledge and experience, JB assumes no obligation or liability for any results obtained in their use or application and they are not to be construed as establishing any warranty, expressed or implied. In no event shall JB be liable for claims for any damages whatsoever (whether direct, foreseeable, consequential or special) suffered by buyer or anyone else arising out of any breach by JB. JB makes no warranty to those defined as consumers in the Magnuson-Moss Warranty-Federal Trade Commission Improvement Act.

Disclaimers: All tool items pictured, described or otherwise displayed herein are subject to change, alteration and/or modification at any time by JB Industries, Inc. The terms and conditions for the purchase of JB Industries, Inc. tools are subject to change, alteration and/or modification at any time by JB Industries, Inc. and will be made available upon request to JB Industries Inc. and shall be provided to customers of JB Industries, Inc. at time of purchase.

Over-the-Counter (OTC) Warranty: Applies ONLY to newly purchased F6™ Refrigerant Recovery Machine (3 year OTC), PLATINUM® Vacuum Pumps (2 year OTC), ELIMINATOR® Vacuum Pumps (2 year OTC) and PLATINUM® FLEX Vacuum Pumps (1 year OTC). OTC Warranty is limited to manufacturing defects and is VOID if the problem has been determined to be caused by abuse or misuse.

Lifetime Manifold Bar Warranty: Manifold bar only has a lifetime warranty, while the components, i.e. gauges, hoses, handles, hose holders, etc. are covered under the limited warranty policy.

For Professional Use Only: JB manifolds and tools are designed for use by technically trained HVACR service engineers only. Due to the high pressures encountered in all systems that manifolds will be used on, plus the dangers due to the physical and chemical nature of refrigerants and oils present in all systems, misapplication could result in injury or death.

RETURN FOR REPAIR

JB provides reliable, superior quality tools—However, in the event your instrument requires repair, you are required to contact JB Customer Service Department to obtain a Return Goods Authorization (RGA) number.

Ensure that all returned tools are packed to avoid damage in shipment. Warranty claims for items damaged in transit will not be honored. Refrain from applying stickers or strong tape on tool face as item may be returned with no manufacturer defects. Paperwork should be placed in a separate plastic bag and should include JB's assigned RGA number, a description of the problem, copy of invoice and any customer assigned repair or purchase order number, if applicable. Please provide contact information (name/address/phone/email) of whom to inform of package receipt as well as the person authorized to accept repair charges should the warranty be void. Tool returns for repair will not be accepted without an RGA number from JB Industries.

Contact Customer Service for RGA number:

800.323.0811 Toll-free 630.851.9444 Tel
800.552.5593 Toll-free Fax 630.851.9448 Fax

Tools should be shipped with freight prepaid to:

JB Industries
RGA# _____
601 N. Farnsworth Ave.
Aurora, IL 60505 USA

Over-the-Counter (OTC) Warranty: Applies ONLY to newly purchased F6™ Refrigerant Recovery Machine (3 year OTC), PLATINUM® Vacuum Pumps (2 year OTC), ELIMINATOR® Vacuum Pumps (2 year OTC), and PLATINUM® FLEX Vacuum Pumps (1 year OTC). OTC Warranty is limited to manufacturing defects and is VOID if the problem has been determined to be caused by abuse or misuse.

VACUUM PUMPS: 1 AND 2 YEAR OTC WARRANTIES

All warranty statements apply to the PLATINUM® (2-year OTC), PLATINUM® FLEX (1-Year OTC) and ELIMINATOR® (2-year OTC) pumps.

JB Industries vacuum pumps are warranted to be free of defects in materials and workmanship for period indicated from the date of purchase. This warranty applies to all repairable instruments that have not been tampered with or damaged through improper use including unauthorized opening of the unit.

Pumps received within warranty period are assessed upon arrival at the JB Industries facility to determine warranty coverage. Wholesaler will be notified of warranty coverage determination. Over-the-counter warranty applies only to manufacturing defects and is VOID if determination has been deemed tool misuse.

To eliminate unnecessary returns and/or costly repairs, verify oil has been changed and proper pump operation guidelines have been followed prior to requesting a Return Goods Authorization (RGA) number.

NOT CHANGING OIL WILL VOID WARRANTY

CHECK FOR SIGNS OF MISUSE

- A. Housing area
- B. Broken base
- C. Trap
- D. Damage to fins or drain valve
- E. Sight glass
- F. Damage or dents to pump body
- G. Broken or bent handle
- H. Damaged or missing intake valve

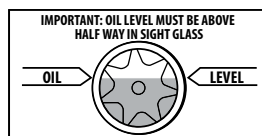

REASONS FOR VOID OF WARRANTY

- Improper usage of pump and pump oil
- Oil has not been changed
- Corrosive substances and/or contaminants found in pump
- Pump has been damaged, altered or components have been removed or are missing

PACKING VACUUM PUMP FOR RETURN

To ensure that no additional charges are incurred due to improper packaging:

1. Drain **all** oil from pump and close off valves.
2. Place pump in a sealed plastic bag.
3. Package pump in a cushioned bottom carton with packing paper. Be sure to secure and protect pump in carton on all sides. Do not use packing peanuts.
4. Include RGA number issued by JB Industries and supporting paperwork with detailed description of issue in a sealed, separate plastic bag.
5. If an estimate is required, be sure to specify in documentation and include contact information (name/address/phone/email).

F6-DP: 3 YEAR OTC WARRANTY

JB Industries warrants the F6-DP Refrigerant Recovery Machine to be free from defects of materials or workmanship for three years from the date of purchase. JB Industries does not warrant any machine that has been subjected to misuse, negligence or accident, or has been repaired or altered by anyone other than JB Industries.

The compressor is warranted for a period of three years by the manufacturer. To keep this warranty in force, a filter (included) must be used on the inlet port or hose at all times to prevent particulates from entering the compressor. Failure to use the included filter will void the compressor warranty.

JB Industries liability is limited to repairing or replacing, at its option, a defective machine or part. If a defect arises, a valid claim must be received by JB Industries, with transportation prepaid, no later than thirty (30) days after the warranty period expires. JB Industries will determine whether the machine has malfunctioned due to defective materials or workmanship.

PLATINUM® Vacuum Pump Repair DV-42N through DV-285N Series

Repair parts can be ordered from your local JB wholesaler. When ordering, please provide the following information:

- Model number
- Serial number
- Part number and description

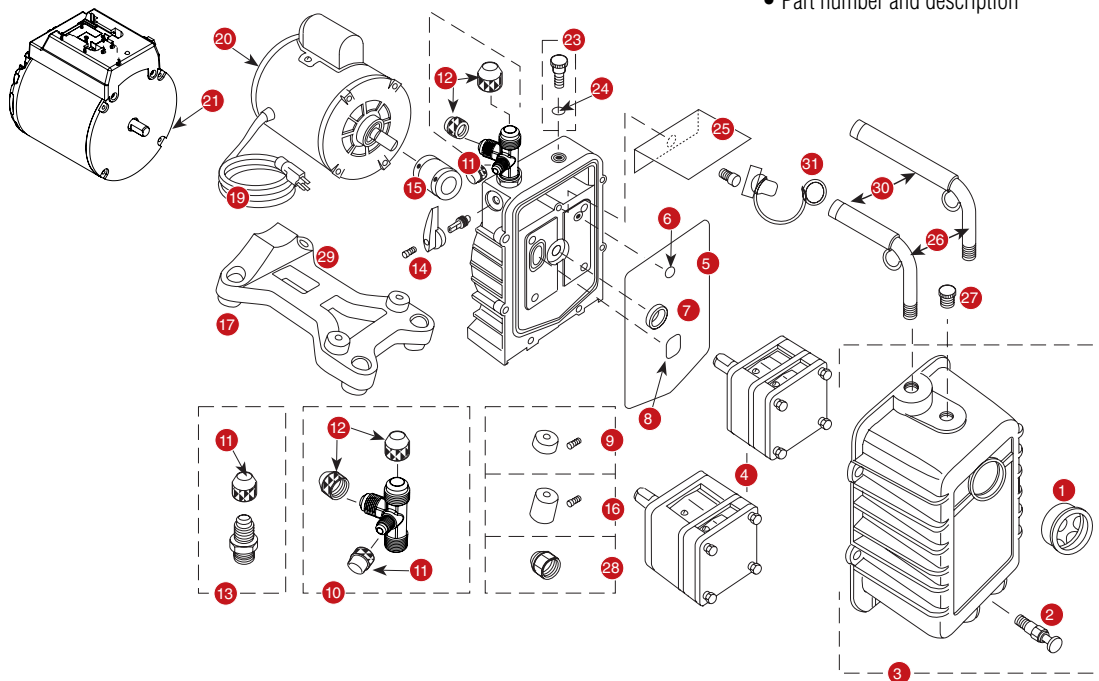

PLATINUM® SERIES REPAIR PARTS – ALL MODELS		
REF.NO.	PART NO.	DESCRIPTION
1	PR-1	Sight glass
2	PR-2	Drain valve
6	PR-211	Trap o-ring, gas ballast
7	PR-3	Shaft seal
8	PR-315	Trap o-ring, intake
9	PR-4	Rubber foot and screw assembly – 1 per package (Prior to 2006)
10	PR-66	Angled intake tee with caps
11	NFT5-4	1/4" O-ring, cap
12	NFT5-6	3/8" O-ring, cap
	NFT5-8	1/2" O-ring, cap
	PR-209	Plastic isolation valve handle and screw w/stem, o-rings and retainer
15	PR-208	Flexible coupler* 1-1/2"(Start of 1995) 2-1/2" (Prior to 12/1994)*
	PR-308	Flexible section only 7/8"; use w/PR-208 flexible coupler*
	PR-6	Flexible coupler* 2-1/4"
16	PR-42	Motor foot w/screw (prior to 2006)
17	PR-59	Base foot
19	PR-31	Line cord (Marathon motor) old style
20	PR-54	Rocker switch w/wire leads (Emerson) models since 2004
21	PR-607	FLEX motor
	PR-206	1/2 Hp, 115v, 60 Hz Motor w/line cord and switch
	PR-207	1/2 Hp, 115/230v, 50/60 Hz Dual Voltage Motor (not shown)
	PR-307	1/2 Hp, 115/230v, 50/60 Hz Spark Proof Motor (not shown)
23	PR-7	Gas ballast valve w/o-ring
24	P90009	O-ring, gas ballast valve
25	PR-40	Splash guard and screw (excludes 3 CFM manufactured before 1/01)

26	PR-75	Cushioned handle w/lift ring 1/2" NPT and DV-EP-8 as of 2008
	PR-205	Cushioned handle 3/8" NPT
	PR-605	Cushioned handle w/lift ring FLEX
27	PR-22	Oil fill plug w/o-ring
28	PR-56	Adapter nut w/nut o-ring
30	PR-500	Cushion and cap 3/8" NPT
	PR-501	Cushion and cap 1/2" NPT
	PR-601	Cushion and cap FLEX
31	DV-EP6	Tethered safety cap 3/8" NPT (prior to 2008)
	DV-EP8	Tethered safety cap 1/2" NPT
PLATINUM® SERIES REPAIR PARTS – MANUFACTURED AFTER JANUARY 2001		
REF.NO.	PART NO.	DESCRIPTION
3	PR-300	DV-42N through DV-200N cover assembly w/sight glass and drain valve
	PR-301	DV-285N Cover assembly w/sight glass and drain valve
4	PR-302	DV-42N and DV-85N Cartridge w/o-rings and cover seal
	PR-303	DV-142N Cartridge w/o-rings and cover seal
	PR-304	DV-200N Cartridge w/o-rings and cover seal
	PR-314	DV-285N Cartridge w/o-rings and cover seal
5	PR-311	Cover seal
13	PR-32	1/4" Intake w/cap
29	PR-62	Pump base (includes feet); fits all pumps with serial #0101 and higher
PLATINUM® SERIES REPAIR PARTS – MANUFACTURED BEFORE JANUARY 2001		
5	PR-217	Cover seal
8	PR-215	Trap o-ring, intake
PLATINUM® SERIES REPAIR PARTS – NOT SHOWN		
PR-18	Cartridge valve repair kit (includes DV-285N as of 2007 models)	
PR-52	DV-285N Cartridge valve repair kit (prior to 2007 models)	
PR-45	Pump repair kit PR-1, PR-59 (4), PR-42, PR-208	

Emerson® is a registered trademark of US Motors. Marathon® is a registered trademark of Marathon Electric.
* Coat with thread sealant when replacing.

PLATINUM® BEAST Vacuum Pump Repair DV-340N

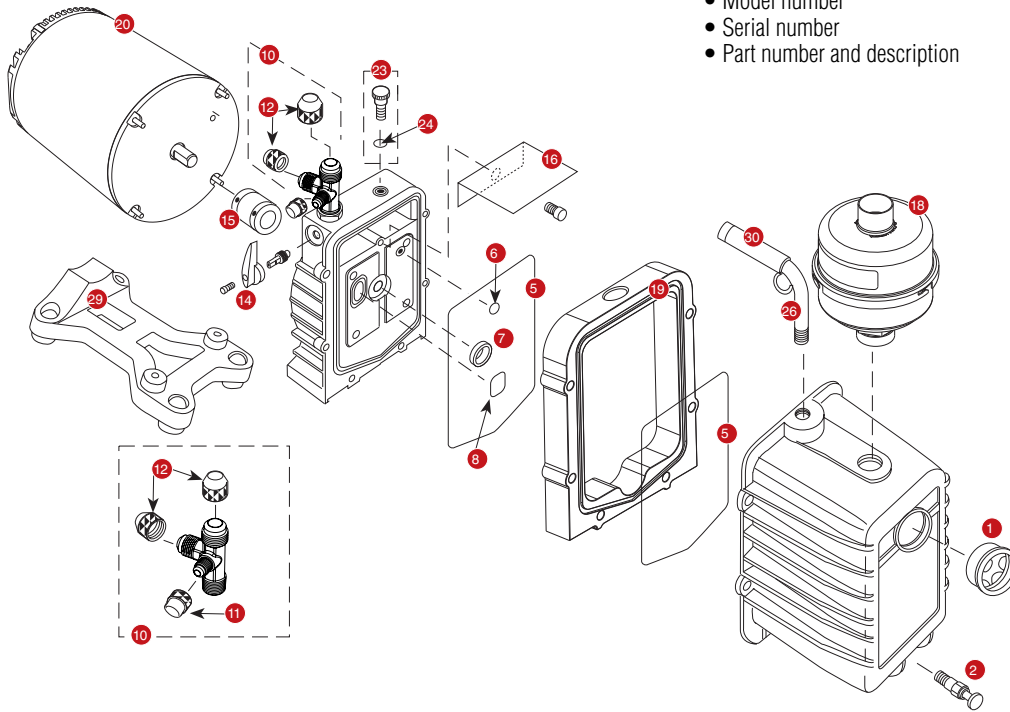

Repair parts can be ordered from your local JB wholesaler. When ordering please provide the following information:

- Model number
- Serial number
- Part number and description

PLATINUM® BEAST REPAIR PARTS		
REF.NO.	PART NO.	DESCRIPTION
1	PR-1	Sight glass
2	PR-2	Drain valve
6	PR-211	Trap o-ring, gas ballast
7	PR-3	Shaft seal
8	PR-315	Trap o-ring, intake
10	PR-78	Angled intake tee with caps
11	NFT5-4	1/4" O-ring, cap
	NFT5-6	3/8" O-ring, cap
	NFT5-8	1/2" O-ring, cap
14	PR-209	Plastic isolation valve handle and screw w/stem, o-rings and retainer
15	PR-208	Flexible coupler* 1-1/2"(Start of 1995) 2-1/2" (Prior to 12/1994)*
	PR-308	Flexible section only 7/8"; use w/PR-208 flexible coupler*
16	PR-41	Splash Guard
17	PR-59	Base
18	PR-307	Filter
19	PR-306	Spacer
20	PR-607	Motor
23	PR-7	Gas ballast valve w/o-ring
24	P90009	O-ring, gas ballast valve

* Coat with thread sealant when replacing.

PLATINUM® BEAST REPAIR PARTS		
REF.NO.	PART NO.	DESCRIPTION
26	PR-75	Cushioned handle w/lift ring 1/2" NPT
27	PR-22	Oil fill plug w/o-ring
28	PR-56	Adapter nut w/nut o-ring
30	PR-501	Cushion and cap 1/2" NPT
3	PR-301	DV-285N Cover assembly w/sight glass and drain valve
5	PR-311	Cover seal
29	PR-62	Pump base (includes feet); fits all pumps with serial #0101 and higher
PLATINUM® BEAST REPAIR PARTS – NOT SHOWN		
PR-45	Pump repair kit PR-1, PR-59 (4), PR-2, PR-208	

ELIMINATOR® Vacuum Pump Repair DV-3E, DV-4E and DV-6E Series

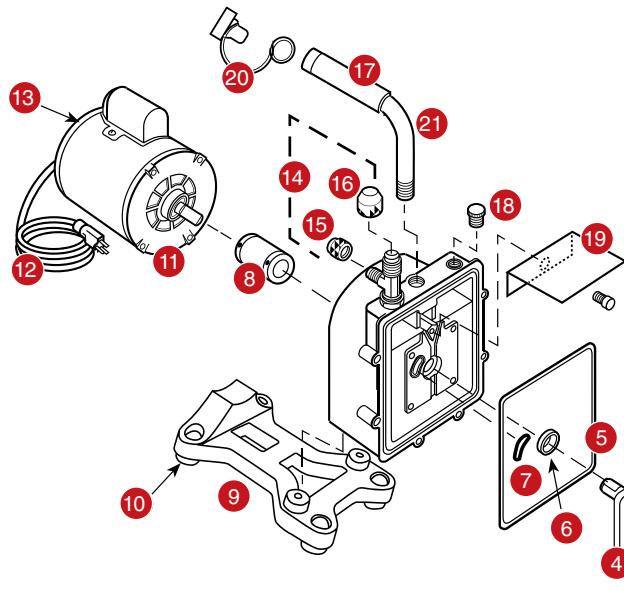

Repair parts can be ordered from your local JB wholesaler. When ordering, please provide the following information:

- Model number
- Serial number
- Part number and description

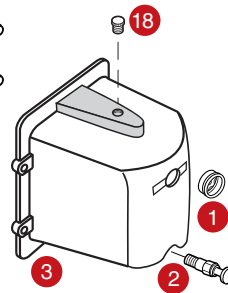

Current chrome cover will fit older black ELIMINATOR models

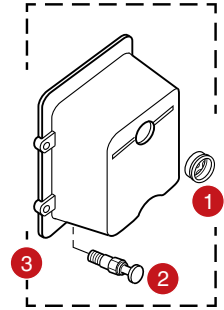

Black hammertone cover no longer available

ELIMINATOR SERIES REPAIR PARTS		
REF.NO.	PART NO.	DESCRIPTION
1	PR-1	Sight glass
2	PR-2	Oil drain valve
3	PR-10	DV-3E, DV-4E and DV-6E cover assembly w/sight glass, drain valve and oil fill plug
4	PR-403	DV-3E Cartridge complete w/o-rings and cover seal
	PR-404	DV-4E Cartridge complete w/o-rings and cover seal
	PR-406	DV-6E Cartridge complete w/o-rings and cover seal
5	PR-217	Cover seal
6	PR-3	Shaft seal
7	PR-315	Trap intake o-ring
8	PR-208	1-1/2" Flexible coupler*
	PR-308	7/8" Middle section; used w/PR-208 2-1/2" Flexible coupler*
	PR-6	2-1/4" Flexible coupler*
	PR-77	1-5/8" Middle section; used w/PR-6 flexible coupler*
9	PR-62	Pump base w/rubber feet and screws (4)
10	PR-59	Rubber pump foot (1)
Not Shown	PR-18	Cartridge valve repair kit

ELIMINATOR SERIES REPAIR PARTS		
REF.NO.	PART NO.	DESCRIPTION
11	PR-206	1/2 HP, 115v/60Hz motor w/line cord and switch
	PR-207	1/2 HP, 115/230v, 50/60Hz dual voltage motor w/line cord and switch (not shown)
	PR-307	1/2 Hp, 115/230v, 50/60 Hz Spark Proof Motor (not shown)
12	PR-31	6' Line cord (Emerson® motor)
13	PR-54	Rocker-switch 115v Emerson Motor (wire leads)
14	PR-63	Intake tee w/cap
15	NFT5-4	1/4" O-ring cap
16	NFT5-6	3/8" O-ring cap
17	PR-500	3/8" Rubber grip and cap
	PR-501	1/2" Rubber grip and cap
18	PR-22	Oil fill plug w/o-ring
19	PR-40	Stainless steel splash guard w/screw
20	DV-EP6	3/8" Red tethered safety exhaust cap
	DV-EP8	1/2" Red tethered safety exhaust cap
21	PR-205	3/8" Cushioned handle
	PR-65	1/2" Cushioned handle

Emerson® is a registered trademark of US Motors. Marathon® is a registered trademark of Marathon Electric.
 * Coat with thread sealant when replacing.

Manifold Rebuild Kits

- Rebuild kits are available for all manifold series
- Standard rebuild kits include a stem, nut, piston with seat and o-rings
- Premium rebuild kits feature two standard kits plus two handwheels and screws
- Caution: gauges and hoses not specified for R410A can damage tools and cause injury

ZEPPELIN® Brass Series

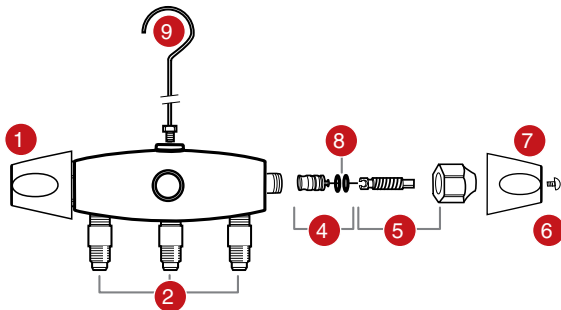

ZEPPELIN® 2-Valve Aluminum Series

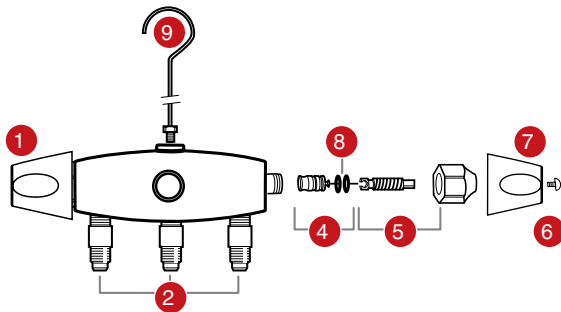

ZEPPELIN® 4-Valve Aluminum Series

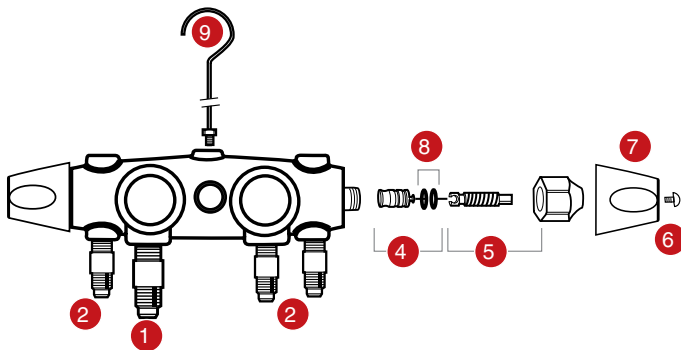

MANIFOLD REBUILD KITS	
PART NO.	DESCRIPTION
M2R-S	Standard M2 rebuild (also fits M5 through M9 series)
M2R-P	Premium M2 rebuild (fits M2 series only)
M4R-S	Standard M4 rebuild
M4R-P	Premium M4 rebuild
2VZR-S	Standard ZEPPELIN 2-valve rebuild (fits both aluminum and brass)
2VZR-P	Premium ZEPPELIN 2-valve rebuild (fits both aluminum and brass)
4VZR-S	Standard ZEPPELIN 4-valve rebuild
4VZR-P	Premium ZEPPELIN 4-valve rebuild
M2-106	1/8" FPT Gauge mounting brackets
M2-108	1/4" FPT Gauge mounting brackets

ZEPPELIN BRASS SERIES MANIFOLD		
REF.NO.	PART NO.	DESCRIPTION
1	MR-601	Handwheel and screw
2	U1-4A	1/4" Intake
4	MR-505	1/4" Manifold piston
5	MR-516	Stem and nut
6	MR-601	Handwheel and screw
7	MR-503	Handwheel screws (2)
8	MR-509	O-rings (2)
9	M2-102N	Hanging hook

ZEPPELIN 2-VALVE ALUMINUM		
REF.NO.	PART NO.	DESCRIPTION
1	MR-601	Handwheel and screw
2	U1-4A	1/4" Intake
4	MR-505	Piston w/seat and o-rings
5	MR-516	Stem and nut
6	MR-601	Handwheel and screw
7	MR-503	Handwheel screws (two)
8	MR-509	O-rings (two)
9	M2-102N	Hanging hook

ZEPPELIN 4-VALVE ALUMINUM		
REF.NO.	PART NO.	DESCRIPTION
1	U1-6B	3/8" Intake
2	U1-4A	1/4" Intake
4	MR-605	Piston w/seat and o-rings
5	MR-607	Stem and nut
6	MR-601	Handwheel and screw
7	MR-503	Handwheel screws (2)
8	MR-409	O-rings (2)
9	M2-102N	Hanging hook

Repair

M2 Series

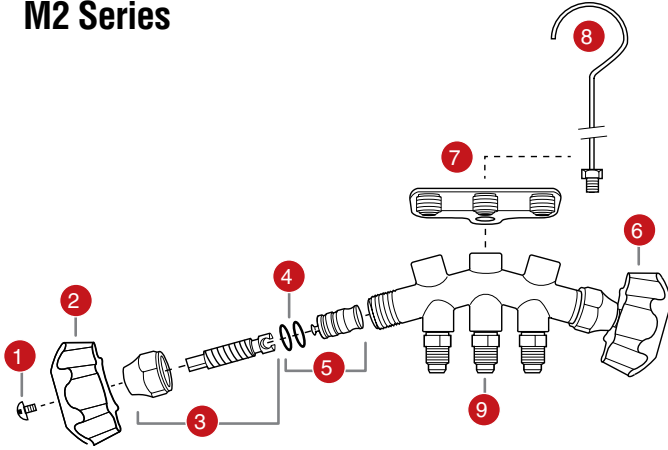

M2 SERIES MANIFOLDS		
REF.NO.	PART NO.	DESCRIPTION
1	MR-503	Handwheel screw (2)
2	MR-501B	Blue handwheel and screw
3	MR-516	Stem and nut
4	MR-509	O-ring (2)
5	MR-505	Piston w/seat and o-rings
6	MR-501R	Red handwheel
7	M2-300	Hose holder 1/4"
8	M2-102N	Hanging hook
9	U1-4A	Intake

PATRIOT™ Series

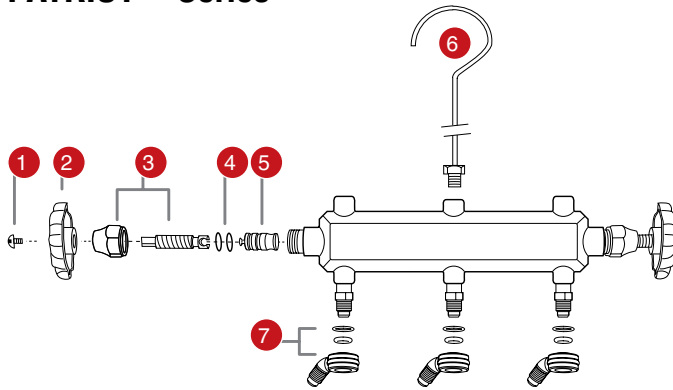

PATRIOT SERIES MANIFOLDS		
REF.NO.	PART NO.	DESCRIPTION
1	MR-503	Handwheel screw (2)
2	MR-508	Metal handwheel and screw
3	MR-516	Stem and nut
4	MR-509	O-ring (2)
5	MR-505	Piston w/seat and o-rings
6	M2-102N	Hanging hook
7	MR-504	1/4" Hose holder sleeve and o-rings

REVOLVER® Series

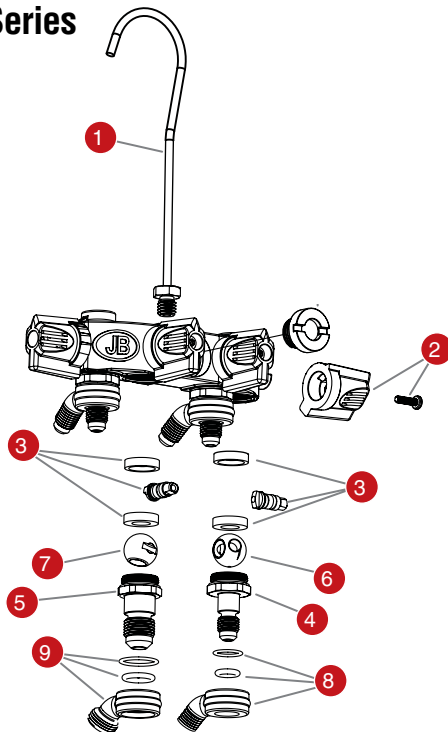

REVOLVER 4-VALVE BALL SERIES MANIFOLD		
REF.NO.	PART NO.	DESCRIPTION
1	M2-102N	Hanging hook
2	MR-502	Handle and screw
3	MR-BVK	Ball valve kit including: seals (2), stem (1), o-rings (2) and washer (1)
4	MR-444	1/4" Retainer fitting
5	MR-446	3/8" Retainer fitting
6	MR-611	Throttle ball
7	MR-610	Ball
8	MR-504	1/4" Hose holder sleeve and o-rings
9	MR-506	3/8" Hose holder sleeve and o-rings

100-A.....57	122-E.....56	25040.....25	27770.....27	28584.....27	29337.....29
100-B.....57	13493.....47	25044.....25	27772.....27	28586.....27	29338.....29
100-C.....57	13494.....47	25050.....25	27774.....27	28588.....27	29384.....29
100-D.....57	19571.....71	25058.....25	27776.....27	28592.....27	29385.....29
100-E.....57	22125.....22	25065.....25	27780.....27	28596.....27	29433.....28
101-A.....57	22133.....22	25069.....25	27782.....27	28597.....27	29435.....28
101-B.....57	22225.....22	25100.....25	27784.....27	28599.....27	29436.....28
101-C.....57	22225CM.....22	25108.....25	27786.....27	28732.....27	2VZR-P.....77
101-D.....57	22433.....22	25125.....25	27788.....27	28735.....27	2VZR-S.....77
101-E.....57	22225L.....22	25133.....25	27852.....27	28752.....27	30744.....27
103-A.....57	22233.....22	25140.....25	27854.....27	28754.....27	33112N.....35
103-B.....57	22233CM.....22	25144.....25	27859.....27	28759.....27	33112RK.....35
103-C.....57	22233L.....22	25150.....25	27870.....27	28770.....27	33113N.....35
103-D.....57	22246.....22	25158.....25	27872.....27	28772.....27	33115N.....35
103-E.....57	22246CM.....22	25165.....25	27874.....27	28774.....27	33115RK.....35
110-BA.....57	22500.....22,36,37	25169.....25	27880.....27	28776.....27	33116N.....35
110-CA.....57	22505.....22,36,37	25200.....25	27882.....27	28780.....27	42019.....71
110-CB.....57	22525.....22	25208.....25	27884.....27	28782.....27	4VZR-P.....77
110-DA.....57	22531.....22	25225.....25	27886.....27	28784.....27	4VZR-S.....77
110-DB.....57	22600.....22,36,37	25225L.....25	27888.....27	28786.....27	81LB-4.....57
110-DC.....57	22605.....22,36,37	25233.....25	27952.....27	28788.....27	96820.....71
110-EA.....57	22633.....22	25233L.....25	27954.....27	28832.....27	96822.....71
110-EB.....57	22725.....22	25240.....25	27959.....27	28835.....27	96823.....71
110-EC.....57	22733.....22	25246.....25	27970.....27	28852.....27	A10971.....68
110-ED.....57	22733RF-18.....22,30	25248.....25	27972.....27	28854.....27	A10972.....68
110-FD.....57	22833.....22	25250.....25	27974.....27	28859.....27	A10973.....68
110-FE.....57	22933.....22	25258.....25	27980.....27	28870.....27	A10974.....35,49,67
11175.....71	24000.....24	25265.....25	27982.....27	28872.....27	A31002.....41
112-A.....56	24008.....24	25269.....25	27984.....27	28874.....27	A31003.....41
112-B.....56	24025.....24	25325.....25	27986.....27	28876.....27	A31004.....41
112-C.....56	24033.....24	25425.....25	27988.....27	28880.....27	A31004-CJ.....42
112-D.....56	24040.....24	25500.....25	28102.....27	28882.....27	A31004S.....41
112-E.....56	24044.....24	25508.....25	28105.....27	28884.....27	A31005.....41
113-A15.....56	24050.....24	25523.....25	28170.....27	28886.....27	A31006.....41
113-A2.....56	24058.....24	25525.....25	28172.....27	28888.....27	A31008.....41
113-A25.....56	24065.....24	25533.....25	28174.....27	28932.....27	A31009.....41
113-A3.....56	24069.....24	25548.....25	28176.....27	28935.....27	A31011.....41
113-A35.....56	24100.....24	25550.....25	28180.....27	28952.....27	A31012.....41
113-B15.....56	24108.....24	25558.....25	28182.....27	28954.....27	A31134.....42
113-B2.....56	24125.....24	25573.....25	28184.....27	28959.....27	A31135.....42
113-B25.....56	24133.....24	25608.....25	28186.....27	28970.....27	A31136.....42
113-B3.....56	24140.....24	25708.....25	28188.....27	28972.....27	A31138.....42
113-B35.....56	24144.....24	25713.....25	28192.....27	28974.....27	A31140.....42
113-C15.....56	24150.....24	25825.....25	28196.....27	28976.....27	A31142.....42
113-C2.....56	24158.....24	25833.....25	28197.....27	28980.....27	A31144.....42
113-C25.....56	24165.....24	26000.....23	28199.....27	28982.....27	A31148.....42
113-C3.....56	24169.....24	26008.....23	28202.....27	28984.....27	A31154.....42
113-D15.....56	24200.....24	26025.....23	28205.....27	28986.....27	A31155.....42
113-D2.....56	24208.....24	26033.....23	28270.....27	28988.....27	A31156.....42
113-D25.....56	24225.....24	26040.....23	28272.....27	29260.....29	A31160.....41
113-D3.....56	24233.....24	26044.....23	28274.....27	29263.....29	A31162.....41
113-D35.....56	24240.....24	26100.....23	28276.....27	29280.....29	A31164.....41
11509.....71	24244.....24	26108.....23	28280.....27	29285.....29	A31168.....41
11511.....71	24250.....24	26125.....23	28282.....27	29290.....29	A31199.....42
11575.....71	24258.....24	26133.....23	28284.....27	29292.....29	A31200.....42
116-A.....57	24265.....24	26140.....23	28286.....27	29295.....29	A31201.....42
116-B.....57	24325.....24	26144.....23	28288.....27	29297.....29	A31202.....42
116-C.....57	24425.....24	26200.....23	28292.....27	29310.....29	A31204.....42
116-D.....57	24500.....24	26208.....23	28296.....27	29311.....29	A31234.....44
121-A.....57	24508.....24	26225.....23	28297.....27	29312.....29	A31235.....44
121-B.....57	24525.....24	26225L.....23	28299.....27	29315.....29	A31236.....44
121-C.....57	24533.....24	26233.....23	28502.....27	29316.....29	A31238.....44
121-D.....57	24600.....24	26233L.....23	28505.....27	29317.....29	A31334.....42
121-E.....57	24608.....24	26240.....23	28570.....27	29330.....29	A31335.....42
121-F.....57	24615.....24	26244.....23	28572.....27	29331.....29	A31336.....42
122-A.....56	25000.....25	26246.....23	28574.....27	29332.....29	A31338.....42
122-B.....56	25008.....25	27752.....27	28576.....27	29333.....29	A31340.....42
122-C.....56	25025.....25	27754.....27	28580.....27	29335.....29	A31342.....42
122-D.....56	25033.....25	27759.....27	28582.....27	29336.....29	A31344.....42

Climatic
Class
Digital
Manifolds
Vacuum
Pumps
Recovery
Scales
Digital
Gauges
Leak
Detection
Manifolds/
Gauges
Hoses
Mini-Split
Tool Kits
SHIELD
CoreMax
Access
Valves
Brass
Fittings
Ball
Valves
Just Better
Tools
Capillary
Tubing
Automotive/
LA-CO
Warranty/
Repair
Index/
Contacts

Climate Class	A31348.....42	A32703.....50	CCLBV-72.....33	CL4HD-48.....34	CLRF-18R.....30	CLV-72Y.....34
Digital Manifolds	A31424.....44	A32704.....50	CCLBV4-36.....33	CL4HD-60.....34	CLRF-18Y.....30	CLV5-60B.....34
Vacuum Pumps	A31434.....43	A32804.....41	CCLBV4-48.....33	CL4HD-72.....34	CLS-1200B.....32	CLV5-60R.....34
Recovery	A31444.....44	A32805.....41	CCLBV4-60.....33	CL6-36.....34	CLS-1200R.....32	CLV5-60Y.....34
Scales	A31452.....44	A32806.....41	CCLBV4-72.....33	CL6-36Y.....34	CLS-1200Y.....32	CLV6-36.....34
Digital Gauges	A31454.....44	A32808.....41	CCLBV5-36.....33	CL6-48.....34	CLS-120B.....32	CLV6-48.....34
Leak Detection	A31482.....44	A32810.....41	CCLBV5-60.....33	CL6-48Y.....34	CLS-120R.....32	CLV6-60.....34
Manifolds/ Gauges	A31484.....44	A32812.....41	CCLBV5-72.....33	CL6-60.....34	CLS-120Y.....32	CLV6-6BL.....34
Hoses	A31492.....44	A32814.....41	CCLBV5-72.....33	CL6-60Y.....34	CLS-300B.....32	CLV6-6Y.....34
Mini-Split Tool Kits	A31494.....44	A32818.....41	CCLBV5-72.....33	CL6-72.....34	CLS-300R.....32	CLV6-72.....34
SHIELD	A31512.....44	A32904.....41	CCLBV5-72.....33	CL6-72Y.....34	CLS-300Y.....32	CM-CRTOOL.....39
CoreMax	A31514.....44	A32905.....41	CCLBV5-72.....33	CL64-60.....34	CLS-36B.....32	CM-RBK.....39
Access Valves	A31520.....43	A32906.....41	CCLBV5-72.....33	CL6HD-60.....34	CLS-36R.....32	CM-S250.....39
Brass Fittings	A31522.....43	A32908.....41	CCLBV5-72.....33	CL6HD-60.....34	CLS-36Y.....32	CM-S370.....39
Ball Valves	A31614.....44	A32910.....41	CCLBV5-72.....33	CL6HD-60.....34	CLS-48B.....32	CM-SEAL.....39
Just Better Tools	A31656.....36,37,48	A32912.....41	CCLBV5-72.....33	CL6HD-72.....34	CLS-48R.....32	CM-SNAP.....39
Capillary Tubing	A31665.....36,37,48	A32914.....41	CCLBV5-72.....33	CL744-36.....27	CLS-48Y.....32	CM-SS250.....39
Automotive/ LA-CO	A31720.....44	A33000.....47	CCLBV5-72.....33	CL84-60.....34	CLS-600B.....32	CM-SS370.....39
Warranty/ Repair	A31722.....44	A33004.....43	CCLBV5-72.....33	CLBV-36B.....33	CLS-600R.....32	CM-TRQ.....39
	A31723.....44	A33500.....48	CCLBV5-72.....33	CLBV-36R.....33	CLS-600Y.....32	CM-VC003.....39
	A31724.....44	A33600.....70	CCLBV5-72.....33	CLBV-36Y.....33	CLS-60B.....32	CM-VC010.....39
	A31725.....44	A34000.....48	CCLBV5-72.....33	CLBV-48B.....33	CLS-60R.....32	CM-VC025.....39
	A31726.....44	A34000D.....19	CCLBV5-72.....33	CLBV-48R.....33	CLS-60Y.....32	CM-VC100.....39
	A31727.....43	AC-13430.....70	CCLBV5-72.....33	CLBV-48Y.....33	CLS-72B.....32	CNTL90-12.....30
	A31728.....44	AC-13435.....70	CCLBV5-72.....33	CLBV-60B.....33	CLS-72R.....32	CNTL90-18.....30
	A31729.....44	AC-15530.....70	CCLBV5-72.....33	CLBV-60R.....33	CLS-72Y.....32	CNTL90-24.....30
	A31734.....44	AC-15535.....70	CCLBV5-72.....33	CLBV-60Y.....33	CLS-900B.....32	CNTL90-30.....30
	A31736.....44	AF-13450.....70	CCLBV5-72.....33	CLBV-72B.....33	CLS-900R.....32	CNTL90-36.....30
	A31851.....43	AF-13451.....70	CCLBV5-72.....33	CLBV-72R.....33	CLS-900Y.....32	CNTL90-48.....30
	A31852.....43	AF-13452.....70	CCLBV5-72.....33	CLBV-72Y.....33	CLS5-36B.....32	CNTL90-60.....30
	A31853.....43	AF-13455.....70	CCLBV5-72.....33	CLE-1200B.....33	CLS5-36R.....32	CV-20004.....48
	A31854.....43	AF-13457.....70	CCLBV5-72.....33	CLE-1200R.....33	CLS5-36Y.....32	CV-20006.....48
	A31856.....43	AF-13550.....70	CCLBV5-72.....33	CLE-1200Y.....33	CLS5-48B.....32	D10162.....13
	A31864.....43	AVK-001.....42	CCLBV5-72.....33	CLE-120B.....33	CLS5-48R.....32	D10244.....13
	A31985.....47	B1-10.....50	CCLBV5-72.....33	CLE-120R.....33	CLS5-48Y.....32	D10266.....13
	A31985-100.....47	B1-12.....50	CCLBV5-72.....33	CLE-120Y.....33	CLS5-60B.....32	D10436.....35
	A31986.....47	B1-3.....50	CCLBV5-72.....33	CLE-300B.....33	CLS5-60R.....32	D10472.....35
	A31992.....47	B1-4.....50	CCLBV5-72.....33	CLE-300R.....33	CLS5-60Y.....32	D10636.....35
	A31992-100.....47	B1-6.....50	CCLBV5-72.....33	CLE-300Y.....33	CLS5-72B.....32	D10660.....35
	A31997.....47	B1-8.....50	CCLBV5-72.....33	CLE-36B.....33	CLS5-72R.....32	DM4-BRK.....6,7
	A31998.....47	B2-10.....50	CCLBV5-72.....33	CLE-36R.....33	CLS5-72Y.....32	DM4-BT.....6,7
	A31999.....46	B2-12.....50	CCLBV5-72.....33	CLE-36Y.....33	CLS5-72Y.....32	DM4-CS.....6,7
	A31999-100.....46	B2-3.....50	CCLBV5-72.....33	CLE-48B.....33	CLS5-72Y.....32	DM4-CS.....6,7
	A31999-25.....46	B2-4.....50	CCLBV5-72.....33	CLE-48R.....33	CLS5-72Y.....32	DM4-RW.....6
	A32004.....46	B2-5.....50	CCLBV5-72.....33	CLE-48Y.....33	CLS5-72Y.....32	DM4-STRP.....6,7
	A32008.....46	B2-6.....50	CCLBV5-72.....33	CLE-48Y.....33	CLS5-72Y.....32	DM4-TC.....6,7
	A32008-B.....46	B2-8.....50	CCLBV5-72.....33	CLE-600B.....33	CLS5-72Y.....32	DM4-ZW.....7
	A32008-BX.....46	BRZ1000.....67	CCLBV5-72.....33	CLE-600R.....33	CLS5-72Y.....32	DS-20000.....17
	A32100.....46	BS-10.....64	CCLBV5-72.....33	CLE-600Y.....33	CLS5-72Y.....32	DS-250.....17
	A32101.....46	BS-12.....64	CCLBV5-72.....33	CLE-60B.....33	CLS5-72Y.....32	DS-5000.....16
	A32500N.....46	BS-14.....64	CCLBV5-72.....33	CLE-60R.....33	CLS5-72Y.....32	DSR-10.....17
	A32501N.....46	BS-4.....64	CCLBV5-72.....33	CLE-60Y.....33	CLS5-72Y.....32	DSR-20.....17
	A32504.....46	BS-5.....64	CCLBV5-72.....33	CLE-72B.....33	CLS5-72Y.....32	DSR-30.....17
	A32505N.....46	BS-55.....64	CCLBV5-72.....33	CLE-72R.....33	CLS5-72Y.....32	DV-142-FLEX.....9
	A32525N.....12,36,37,46	BS-6.....64	CCLBV5-72.....33	CLE-72Y.....33	CLS5-72Y.....32	DV-142-FLEX-AC.....9
	A32525SV.....12,45	BS-7.....64	CCLBV5-72.....33	CLE-900B.....33	CLS5-72Y.....32	DV-142-FLEX-BAT.....9
	A32525SVT.....12,45	BS-8.....64	CCLBV5-72.....33	CLE-900R.....33	CLS5-72Y.....32	DV-142N.....10
	A32530N.....46	BS-77.....64	CCLBV5-72.....33	CLE-900Y.....33	CLS5-72Y.....32	DV-142N-250.....10
	A32535N.....12,36,37,46	C1-4.....62	CCLBV5-72.....33	CLE5-36B.....33	CLS5-72Y.....32	DV-142N-250EU.....10
	A32535SV.....45	C1-6.....52	CCLBV5-72.....33	CLE5-36R.....33	CLS5-72Y.....32	DV-142N-250UK.....10
	A32535SVT.....45	C33804.....68	CCLBV5-72.....33	CLE5-36Y.....33	CLS5-72Y.....32	DV-200N.....10
	A32600.....50	C33808.....68	CCLBV5-72.....33	CLE5-60B.....33	CLS5-72Y.....32	DV-200N-250.....10
	A32601.....50	C33808-CTN.....68	CCLBV5-72.....33	CLE5-60R.....33	CLS5-72Y.....32	DV-200N-250EU.....10
	A32602.....50	CCL-36.....34	CCLBV5-72.....33	CLE5-60Y.....33	CLS5-72Y.....32	DV-200N-250SP.....10
	A32603.....50	CCL-48.....34	CCLBV5-72.....33	CLE5-72B.....33	CLS5-72Y.....32	DV-200N-250UK.....10
	A32604.....50	CCL-60.....34	CCLBV5-72.....33	CLE5-72R.....33	CLS5-72Y.....32	DV-22N.....18
	A32605.....50	CCL-72.....34	CCLBV5-72.....33	CLE5-72Y.....33	CLS5-72Y.....32	DV-24N.....18
	A32700.....50	CCLBV-36.....33	CCLBV5-72.....33	CLP-6B.....34	CLS5-72Y.....32	DV-240DC.....10
	A32701.....50	CCLBV-48.....33	CCLBV5-72.....33	CLP-6R.....34	CLS5-72Y.....32	DV-27N.....18
	A32702.....50	CCLBV-60.....33	CCLBV5-72.....33	CLP-6Y.....34	CLS5-72Y.....32	DV-285N.....10
			CCLBV5-72.....33	CLRF-18B.....30	CLS5-72Y.....32	DV-285N-250.....10

DV-285N-250EU... 10	E1-8D.....51	HNS4-12.....52	M2-465.....29	MR-501B.....78	NS4-6-CS.....50
DV-285N-250UK... 10	E1-8E.....51	HNS4-4.....52	M2-472.....28,29	MR-501R.....78	NS4-8.....50
DV-29.....20	E2-10.....51	HNS4-6.....52	M2-473.....28,29	MR-502.....78	NS4-8-CS.....50
DV-291.....20	E2-12.....51	HNS4-8.....52	M2-5.....26	MR-503.....7,778	NST4-10.....52
DV-292.....20	E2-2.....51	JB-BACKPACK1..36,37	M2-5-410A.....26	MR-504.....78	NST4-4.....52
DV-293.....20	E2-3.....51	JB-TOOLBAG1..36,37	M2-5-410A-SS...26	MR-505.....7,778	NST4-6.....52
DV-294.....20,35	E2-4.....51	K1-1.....53	M2-5-410AB.....26	MR-506.....78	NST4-8.....52
DV-295.....20	E2-5.....51	K1-3.....53	M2-500.....29	MR-508.....78	NV62-4.....58
DV-3E.....11	E2-6.....51	K1-5.....53	M2-5B.....26	MR-509.....7,778	P2-10.....53
DV-3E-250.....11	E2-8.....51	K1-8.....53	M2-6.....26	MR-516.....7,778	P2-12.....53
DV-3E-250EU.....11	E3-10D.....51	K1-D.....53	M2-600.....28,29	MR-517.....28	P2-3.....53
DV-3E-250UK.....11	E3-10E.....51	K1-E.....53	M2-605.....28,29	MR-533.....28	P2-4.....53
DV-340N.....8	E3-4A.....51	LC-4.....48	M2-6B.....26	MR-590.....28	P2-5.....53
DV-40AC.....19	E3-4B.....51	LC-5.....48	M2-8.....26	MR-593.....28	P2-6.....53
DV-40C.....19	E3-5B.....51	LD-3000.....21	M2-8-410A.....26	MR-594.....28	P2-8.....53
DV-40HK.....19	E3-6A.....51	LD-5000.....21	M2-8-410AB.....26	MR-595.....28	P325.....12,45,46,49
DV-41.....19	E3-6B.....51	LD-CS.....21	M2-800.....29	MR-596.....28	P509.....47,49
DV-42N.....10	E3-6C.....51	LD-PK.....21	M2-805.....29	MR-596L.....28	P509-25.....47,49
DV-42N-250.....10	E3-6D.....51	LD-RF5.....21	M2-808.....27	MR-598.....28	P510.....49
DV-42N-250EU.....10	E3-8C.....51	LD-S101.....21	M2-810.....28,29	MR-601.....77	P511.....18,19,35,59
DV-42N-250UK.....10	E3-8D.....51	LD-ST.....21	M2-815.....29	MR-605.....77	P511-10.....18,19,49
DV-4E.....11	E3-8E.....51	LD-TV.....21	M2-820.....28,29	MR-607.....77	P90008.....35,49
DV-4E-250.....11	E4-44.....50	LDC-4000.....21	M2-820L.....28,29	MR-610.....78	P90009..13,18,20,35,47,48,49,74,75
DV-4E-250EU.....11	E4-66.....50	LDC-4000-1.....21	M2-825.....29	MR-611.....78	P90010.....47,49
DV-4E-250UK.....11	E4-88.....50	LDC-4000-2.....21	M2-825L.....28,29	MR-BVK.....78	P90011.....47,49
DV-6E.....11	ER2-108.....51	LDC-4000-3.....21	M2-826.....29	MSKIT1.....36,37	P90012.....13,35,49
DV-6E-250.....11	ER2-64.....51	LDC-4000-4.....21	M2-827.....29	MSKIT2.....36,37	P90016.....35,49
DV-6E-250EU.....11	ER2-84.....51	LT-456.....47	M2-828.....29	MSKIT3.....36,37	P90022.....35,49
DV-6E-250SP.....11	ER2-86.....51	LT-810.....47	M2-829.....29	N4-10.....52	P90513.....49
DV-6E-250UK.....11	ES2-44.....50	M2-102N.....7,778	M2-830.....29	N4-12.....52	P90514.....18,35,49
DV-85-FLEX.....9	ES2-66.....50	M2-106.....77	M2-831.....29	N4-4.....52	PR-1.....74,75,76
DV-85-FLEX-AC.....9	ES2-68.....50	M2-108.....77	M2-844.....29	N4-5.....52	PR-10.....76
DV-85-FLEX-BAT...9	ES2-88.....50	M2-21125.....26	M2-845.....29	N4-6.....52	PR-18.....74,76
DV-85N.....10	ES4-1010.....51	M2-21125B.....26	M2-851.....29	N4-8.....52	PR-2.....74,75,76
DV-85N-250.....10	ES4-1212.....51	M2-21131.....26	M2-856.....29	N5-10.....52	PR-205.....74,76
DV-85N-250EU.....10	ES4-44.....51	M2-21131B.....26	M2-860.....28,29	N5-12.....52	PR-206.....74,76
DV-85N-250UK.....10	ES4-66.....51	M2-21525.....26	M2-861.....28,29	N5-3.....52	PR-207.....74,76
DV-BP-AC.....9	ES4-88.....51	M2-21525B.....26	M2-862.....28,29	N5-4.....52	PR-208.....74,75,76
DV-BP-BAT.....9	EZ-40288.....47	M2-21531.....26	M2-865.....29	N5-5.....52	PR-209.....74,75
DV-BP-CHRG.....9	EZ-40288-126...47	M2-21531B.....26	M2-870.....29	N5-6.....52	PR-211.....74,75
DV-EP6.....74,76	F6-110-CRD.....15	M2-22125.....26	M2-871.....28,29	N5-8.....52	PR-215.....74
DV-EP8.....74,76	F6-BH.....15	M2-22131.....26	M2-872.....28,29	NFT5-4...36,37,47,74,75,76	PR-217.....74,76
DV-F6.....13	F6-BOOST.....14	M2-22225.....26	M2-875.....29	NFT5-4-100.....47	PR-3.....74,75,76
DV-F8.....13	F6-DP.....15	M2-22231.....26	M2-876.....28,29	NFT5-4-101.....54	PR-300.....74
DV-FILTER.....18,19	F6-DP-250.....15	M2-22244.....26	M2-877.....28,29	NFT5-4-25.....47	PR-301.....74
DV-T1.....13	F6-FLT.....15	M2-22325.....26	M2-880.....29	NFT5-4-CJ.....42	PR-302.....74
DVO-1.....13	F6-RBFT.....15	M2-22425.....26	M2-885.....29	NFT5-5...36,37,47,74,75,76	PR-303.....74
DVO-12.....13	F6-RH.....15	M2-22525.....26	M2-890.....29	NFT5-6.....47	PR-304.....74
DVO-24.....13	F6-RHP.....15	M2-22531.....26	M2-895.....29	NFT5-6-100.....47	PR-307.....74,75,76
DVR-22.....18	F6-STRAP.....15	M2-22825.....26	M2-8B.....26	NFT5-6-101.....54	PR-308.....74,75,76
E1-10C.....51	FP-A-168.....52	M2-22831.....26	M2-924.....29	NFT5-8.....47,74,75	PR-31.....74,76
E1-10D.....51	FP-A-210.....52	M2-23125.....26	M2-924CM.....28,29	NRS4-108.....53	PR-311.....74,75
E1-10E.....51	FP-A-283.....52	M2-23131.....26	M2-925.....29	NRS4-1210.....53	PR-314.....74
E1-12D.....51	FP-B-168.....52	M2-23225.....26	M2-925CM.....29	NRS4-43.....53	PR-315.....74,75,76
E1-12E.....51	FP-B-210.....52	M2-23231.....26	M2-951.....29	NRS4-54.....53	PR-32.....74
E1-2A.....51	FP-B-283.....52	M2-250.....29	M2-956.....29	NRS4-64.....53	PR-4.....74
E1-3A.....51	FP-C-168.....52	M2-300.....78	M2-HP.....27	NRS4-65.....53	PR-40.....74,76
E1-4A.....51	FP-C-210.....52	M2-350.....29	M2-HP-5.....27	NRS4-86.....53	PR-403.....76
E1-4B.....51	FP-C-283.....52	M2-355.....29	M2-LED8PK.....28	NS4-10.....50	PR-404.....76
E1-4C.....51	FU-4B-168.....52	M2-36.....26	M2R-P.....77	NS4-10-CS.....50	PR-406.....76
E1-5A.....51	FU-4B-210.....52	M2-36B.....26	M2R-S.....77	NS4-12.....50	PR-41.....74
E1-5B.....51	FU-4B-283.....52	M2-400.....28,29	M4R-P.....77	NS4-12-CS.....50	PR-45.....74,75
E1-5C.....51	FU-4C-210.....52	M2-405.....29	M4R-S.....77	NS4-3.....50	PR-500.....74,76
E1-6A.....51	FU-4C-283.....52	M2-410.....29	MBV4-01.....35	NS4-4.....50	PR-501.....74,75
E1-6B.....51	FU-6C-168.....52	M2-415.....29	MBV4-03.....35	NS4-4-CS.....50	PR-52.....74,76
E1-6C.....51	FU-6C-210.....52	M2-420.....29	MBV5-01.....35	NS4-5.....50	PR-54.....74,76
E1-6D.....51	FU-6C-283.....52	M2-425.....29	MBV5-03.....35	NS4-6.....50	PR-56.....74,75
E1-6E.....51	GTBG-12.....28	M2-430.....29	MR-409.....77		
E1-8B.....51	GTBG-16.....28	M2-435.....29	MR-444.....78		
E1-8C.....51	HNS4-10.....52	M2-460.....28,29	MR-446.....78		

Climate Class Digital Manifolds Vacuum Pumps Recovery Scales Digital Gauges Leak Detection Manifolds/ Gauges Hoses Mini-Split Tool Kits SHIELD CoreMax Access Valves Brass Fittings Ball Valves Just Better Tools Capillary Tubing Automotive/ LA-CO Warranty/ Repair Index/ Contacts

Climate Class
Digital Manifolds
Vacuum Pumps
Recovery
Scales
Digital Gauges
Leak Detection
Manifolds/Gauges
Hoses
Mini-Split Tool Kits
SHIELD
CoreMax
Access Valves
Brass Fittings
Ball Valves
Just Better Tools
Capillary Tubing
Automotive/LA-CO
Warranty/Repair
Index/Contacts

PR-59..... 74,75,76	RT70015..... 60	T2-12..... 53	TC-59-100..... 68	U3-8B..... 54	V34200..... 59
PR-6..... 74,76	RT70017B..... 60,61	T2-3..... 53	TC-64-10..... 68	U3-8C..... 54	V34201..... 59
PR-601..... 74	RT70017D..... 60,61	T2-4..... 53	TC-64-100..... 68	U3-8D..... 54	V34202..... 59
PR-605..... 74	RT70020..... 60	T2-5..... 53	TC-70-100..... 68	U3-8E..... 54	V34203..... 59
PR-607..... 74,75	RT70021..... 60	T2-6..... 53	TC-70-12..... 68	U4-10..... 55	V34204..... 59
PR-62..... 74,75	RT70027..... 60	T2-8..... 53	TC-75-100..... 68	U4-12..... 55	V34206..... 59
PR-63..... 76	RT70029..... 60	T2-HKA..... 65	TC-75-9..... 68	U4-4..... 55	V34207..... 59
PR-65..... 76	RT70030..... 61	T20095..... 66	TC-80-10..... 68	U4-6..... 55	V34208..... 59
PR-66..... 74	RT70041..... 60	T20195..... 64	TC-80-100..... 68	U4-8..... 55	V34209..... 59
PR-7..... 74,75	RT70056D..... 60	T20203..... 64	TC-85-100..... 68	U5-4A..... 56	V34210..... 59
PR-75..... 74,75	RT70057D..... 61	T20275..... 65	TC-85-9..... 68	U5-4B..... 56	V34211..... 59
PR-77..... 74,76	RT70075..... 67	T20351..... 67	TC-90-100..... 68	U5-6B..... 56	V34300..... 59
PR-78..... 74	RT70105..... 60	T20352..... 67	TC-90-7..... 68	U5-8C..... 56	V34301..... 59
PS-10..... 65	RT70142..... 61	T20353..... 67	TR2-446..... 53	U5-8D..... 56	V34302..... 59
PS-100..... 65	RT70159..... 62	T20500..... 64	TR2-664..... 53	U6-4A..... 55	V34303..... 59
PS-25..... 65	RT70160..... 62	T21000..... 66	TR2-668..... 53	U6-4B..... 55	V34304..... 59
PS-50..... 65	RT70161..... 62	T21002..... 66	TR2-886..... 53	UR2-106..... 55	V34306..... 59
QC-13445-134A... 70	RT70170..... 62	T21003..... 66	TRQ-IMP..... 63	UR2-108..... 55	V34307..... 59
QC-206..... 12,13	RT70171..... 62	T21004..... 66	TRQ1080... 36,37,63	UR2-1210..... 55	V34308..... 59
QC-208..... 12,13	RT70401..... 60	T21005..... 66	U1-10B..... 54	UR2-128..... 55	V34309..... 59
QC-E3..... 48	RT70402..... 60	T21006..... 66	U1-10C..... 54	UR2-43..... 55	V34310..... 59
QC-E4..... 48	RT70521..... 62	T21007..... 66	U1-10D..... 54	UR2-54..... 55	V34311..... 59
QC-E5..... 48	RT70522..... 62	T21008..... 66	U1-10E..... 54	UR2-64..... 55	V34350..... 59
QC-E64..... 13,48	RT70523..... 62	T21010..... 66	U1-12C..... 54	UR2-65..... 55	V34400..... 59
QC-G430..... 28,29	RT70531..... 62	T21012..... 66	U1-12D..... 54	UR2-84..... 55	V34401..... 59
QC-G434..... 29	RT70532..... 62	T21014..... 66	U1-12E..... 54	UR2-86..... 55	V34402..... 59
QC-G460..... 29	RT70534..... 62	T21018..... 66	U1-14E..... 54	UR3-1012..... 55	V34404..... 59
QC-G465..... 29	RT75007..... 61	T21024..... 66	U1-3A..... 54	UR3-108..... 55	V34406..... 59
QC-G820..... 29	RT90614..... 63	T21124U..... 63	U1-3B..... 54	UR3-1210..... 55	V34407..... 59
QC-G825..... 29	RT99016..... 60	T21125U..... 63	U1-4A..... 54,77,78	UR3-43..... 55	V34408..... 59
QC-G851..... 28,29	SH-35-CL..... 19	T21126U..... 63	U1-4B..... 54	UR3-46..... 55	V34409..... 59
QC-G856..... 29	SH-35N..... 19	T21127U..... 63	U1-4C..... 54	UR3-48..... 55	V34500..... 59
QC-S3..... 48	SH-35N-CS..... 19	T21128U..... 63	U1-4D..... 54	UR3-64..... 55	V34501..... 59
QC-S4..... 48	SHLD-3-DRIVER... 38	T21294..... 67	U1-5A..... 54	UR3-68..... 55	V34502..... 59
QC-S45-45..... 48	SHLD-8-DRIVER... 38	T21295..... 35,49	U1-5B..... 54	UR3-810..... 55	V34503..... 59
QC-S46..... 48	SHLD-BIT..... 38	T3-10D..... 54	U1-5C..... 54	UR3-84..... 55	V34504..... 59
QC-S4A..... 48	SHLD-CJ..... 38	T3-4A..... 54	U1-6A..... 54	UR3-86..... 55	V34506..... 59
QC-S4A-134A..... 70	SHLD-COMBO-DRIVER... 38	T3-4B..... 54	U1-6B..... 54,77	US3-1010..... 54	V34507..... 59
QC-S4B..... 48	SHLD-E12..... 38	T3-5B..... 54	U1-6C..... 54	US3-1012..... 54	V34508..... 59
QC-S5..... 48	SHLD-E4..... 36,37,38	T3-6B..... 54	U1-6D..... 54	US3-108..... 54	V34509..... 59
QC-S5S..... 48	SHLD-E50..... 38	T3-6C..... 54	U1-6E..... 54	US3-1212..... 54	V34510..... 59
QC-S64..... 13,48	SHLD-E50..... 38	T3-6D..... 54	U1-8A..... 54	US3-1214..... 54	V34511..... 59
QC-S65..... 48	SHLD-G12..... 38	T3-8C..... 54	U1-8B..... 54	US3-44..... 54	V34525..... 59
REC-TANK-30..... 15	SHLD-G4..... 38	T3-8D..... 54	U1-8C..... 54	US3-45..... 54	V34900..... 58
REC-TANK-50..... 15	SHLD-G50..... 38	T30251..... 65	U1-8D..... 54	US3-46..... 54	V34901..... 58
RT11006..... 67	SHLD-MULTI..... 38	T30600..... 36,37,64	U1-8E..... 54	US3-610..... 54	V34905..... 58
RT12318..... 65	SHLD-P12..... 38	T30600-G... 36,37,65	U2-10..... 55	US3-64..... 54	V34910..... 58
RT21652..... 60,61,67	SHLD-P4..... 36,37,38	T30605..... 36,37,66	U2-12..... 55	US3-65..... 54	VL-100..... 12
RT21652B... 60,61,67	SHLD-P50..... 38	T6-4..... 54	U2-14..... 55	US3-66..... 54	VL-200..... 12
RT21655..... 67	SHLD-SLG20..... 38	TC-100-10..... 68	U2-2..... 55	US3-68..... 54	WC-1..... 4
RT21660..... 67	SHLD-SLP20..... 38	TC-100-100..... 68	U2-3..... 55	US3-810..... 54	WC-2..... 4
RT222402..... 64	SHLD-SLU20..... 38	TC-26-100..... 68	U2-4..... 55	US3-86..... 54	WH-1..... 5
RT222601..... 64	SHLD-U100..... 38	TC-26-16..... 68	U2-4CHK..... 57	US3-88..... 54	WH-2..... 5
RT23022..... 64	SHLD-U12..... 38	TC-31-100..... 68	U2-5..... 55	US4-10..... 55	
RT25131..... 63	SHLD-U4..... 38	TC-31-12..... 68	U2-6..... 55	US4-4..... 55	
RT25136..... 63	SHLD-U50..... 38	TC-36-100..... 68	U2-8..... 55	US4-5..... 55	
RT25140..... 63	SM-18..... 61	TC-36-12..... 68	U3-10C..... 54	US4-6..... 55	
RT25142..... 63	T1-10C..... 53	TC-42-100..... 68	U3-10D..... 54	US4-8..... 55	
RT25151..... 63	T1-10D..... 53	TC-42-12..... 68	U3-10E..... 54	US5-1010..... 50	
RT25913..... 63	T1-4A..... 53	TC-44-100..... 68	U3-2A..... 54	US5-1212..... 50	
RT25914..... 63	T1-4B..... 53	TC-44-12..... 68	U3-3A..... 54	US5-44..... 50	
RT26036..... 64	T1-4C..... 53	TC-49-100..... 68	U3-4A..... 54	US5-66..... 50	
RT26715..... 66	T1-5B..... 53	TC-49-11..... 68	U3-4B..... 54	US5-88..... 50	
RT52000..... 61	T1-6B..... 53	TC-50-100..... 68	U3-4C..... 54	UX1-4A..... 56	
RT52010..... 61	T1-6C..... 53	TC-50-11..... 68	U3-5A..... 54	UX1-4B..... 56	
RT52011..... 61	T1-6D..... 53	TC-54-100..... 68	U3-5B..... 54	UX2-4..... 56	
RT52030..... 61	T1-8B..... 53	TC-54-11..... 68	U3-6A..... 54	V34-RC12..... 58	
RT52042..... 61	T1-8C..... 53	TC-55-100..... 68	U3-6B..... 54	V34-RC19..... 58	
RT70007B..... 60	T1-8D..... 53	TC-55-11..... 68	U3-6C..... 54	V34-RC33..... 58	
RT70007X..... 60	T2-10..... 53	TC-59-10..... 68	U3-6D..... 54	V34-RC4..... 58	

JB Domestic Sales

VICE PRESIDENT OF SALES

OSCAR LOPEZ

P: 817.366.0903
E: oscar@jbind.com

DIRECTOR OF SALES MIDWEST AND EASTERN REGIONS

TOM MUNCEY

P: 847.922.7480
E: tmuncey@jbind.com

DIRECTOR OF SALES WESTERN REGION

TOM MURSALO

P: 714.767.8113
E: tmursalo@jbind.com

REGIONAL SALES – S. TX, LA

PRESTON COLLIER

P: 765.639.9711
E: prestonc@jbind.com

REGIONAL SALES – IN, KY

DUSTIN FULFORD

P: 812.655.6822
E: dustinf@jbind.com

REGIONAL SALES – FL

JEFFREY CHERIF

P: 630.715.8331
E: jeffreyc@jbind.com

Domestic Rep Agencies

MI

CHRISTIAN AND COMPANY

Jeff Christian

P: 248.851.5660
E: jjchvac@aol.com

OH, WV, WESTERN PA

CKA SALES

Matt Graves

P: 614.648.0568
E: matt.graves@ckasales.com

DE, MD, EASTERN PA, NJ, SOUTHERN NY, VA

ENGINEERING EQUIPMENT SALES

Nicole Elia

P: 410.297.8820
E: engeqsal@erols.com

NORTHWEST IN, NORTHERN IL

DANCO SALES COMPANY

Brad Pomeroy

P: 847.381.0101
E: brad@dancosales.net

Domestic Rep Agencies

CT, MA, ME, NH, UPSTATE NY, RI, VT

GIMPER IV

Dan Clark

P: 518.885.8901
E: gimper2@aol.com

IA, SOUTHERN IL, KS, MO, NE

KASCO

Angela Cunningham

P: 913.663.4488
E: angie@kasco.com

CO, ID, MT, NM, UT, WY, EL PASO, TX

PINNACLE PRODUCT SALES

Shaun Caley

P: 303.681.5958
E: shaun@salespps.com

MN, ND, SD, WI

RAC SALES

Brad Rinderknecht

P: 763.785.7000
E: racsales@racsalesinc.com

TX

J&J HVAC LLC

Jim / Jill Malone

P: 817.263.1171 / 817.307.8706
E: jimmalone@sbcglobal.net

NC, SC

RHODES AND STAFFORD

Rick Stafford

P: 336.273.0505
E: rstafford@rhodesandstafford.com

AR, MS, WESTERN TN

SARRIO SALES

Barry Sarrio

P: 901.230.8777
E: barry@sarriosales.com

AL, GA, EASTERN TN

SHUPE, CARBONI & ASSOCIATES

Joe Carboni (GA), Matt Reiners (TN), & Roger Daniel (AL)

P: 800.272.9548
E: sales@shupcarboni.com

AZ, AK, CA, HI, OR, NV, WA

WESTERN COMPONENT SALES

George Kief

P: 888.927.2248 x102
E: george@westerncomponentsales.com

Corey Smith

P: 888.927.2248 x105
E: corey@westerncomponentsales.com

International

MEXICO, LATIN AMERICA

OSCAR LOPEZ

P: 817.366.0903
E: oscar@jbind.com

ASIA-PACIFIC

TOM MUNCEY

P: 847.922.7480
E: tmuncey@jbind.com

EUROPE, MIDDLE EAST, AFRICA

TOM MURSALO

P: 714.767.8113
E: tmursalo@jbind.com

CANADA

ALLTEMP PRODUCTS

Howard Green

P: 800.263.4624
E: sales@alltemp.ca

AUSTRALIA, NEW ZEALAND

ASPEN PUMPS ASIA PACIFIC PTY LTD

Brett Spicer

P: +61 (08) 8186 4666
E: brett.spicer@aspenspumps.com.au

ASIA

MRE INTERNATIONAL

Shepard Goodman

P: 310.459.1333
F: 310.459.5740
E: acexporter@aol.com

Customer Service

JB INDUSTRIES

Toll-free Phone: 800.323.0811
Local Phone: 630.851.9444
Toll-free Fax: 800.552.5593
Local Fax: 630.851.9448
Email: customerservice@jbind.com



JB INDUSTRIES is the premier manufacturer of American-made HVACR tools. For over 50 years, JB has been committed to producing tools of the highest quality while providing exceptional customer service. JB tools are proudly made in the USA since our inception in 1967, with Made in America as an essential part of the company's philosophy. To learn more about our tools and company history visit JBIND.COM.



JBIND.COM | JUST BETTER SINCE 1967 | AMERICAN MADE HVACR TOOLS, VALVES AND FITTINGS