



BOSCH

Installation Manual

Electric Water Heaters

TRONIC 5000T

ES30M | ES40M | ES50M | ES40T | ES50T | ES40LB | ES50LB



⚠ WARNING:

The information in these instructions must be followed exactly. Improper installation, adjustment, service or maintenance can cause property damage, personal injury or death.

⚠ WARNING:

Installation and service must be performed by a qualified installer or service agency.

⚠ WARNING:

Improper installation, adjustment, alteration, service or maintenance can cause injury, death, or property damage.

⚠ WARNING:

READ ALL INSTRUCTIONS BEFORE USING THIS WATER HEATER. Install or locate this water heater only in accordance with the installation instructions. Use this water heater only for its intended use as described in this manual.

BTC 724001301 C / 11.2022

420011167900



Table of Contents

1 Key to Symbols and Safety Instructions	4
1.1 Key to Symbols	4
1.2 Safety	4
2 General Information	6
3 Insulation	7
3.1 Insulation Blanket	7
3.2 Pipe Insulation	7
4 Specifications	8
5 Dimensions	8
6 Water Chemistry Requirements	9
7 Installation	10
7.1 Location	10
7.2 Condensation	10
7.3 Water Lines and Connections	10
7.4 Piping Installation	11
7.5 Closed System /Thermal Expansion	11
7.6 Relief Valves	11
7.7 Recirculating Lines	12
7.8 Turning on Water to Heater	12
7.9 Electrical Diagram	13
7.10 Electrical Connections	14
7.11 Thermostats and Controls	15
7.12 Installation Checklist	15
8 Water Temperature Regulation	17
9 Safety Controls	17
10 Seasonal Operation	17
11 Maintenance	18
11.1 Draining Heater	18
11.2 Test the TPR Valve	19
11.3 Heating Elements	19
11.4 Anode Rod	20
11.5 Water Heater Sounds	20
11.6 Sediment Build-Up	20
11.7 Leakage Checkpoints	21
12 Troubleshooting	22
13 Water Heater Components	23

1 Key to Symbols and Safety Instructions

1.1 Key to Symbols

Warnings



Warnings in this document are identified by a warning triangle printed against a grey background. Keywords at the start of a warning indicate the type and seriousness of the ensuing risk if measures to prevent the risk are not taken.

The following keywords are defined and can be used in this document:

- ▶ **DANGER** indicates a hazardous situation which, if not avoided, will result in death or serious injury.
- ▶ **WARNING** indicates a hazardous situation which, if not avoided, could result in death or serious injury.
- ▶ **CAUTION** indicates a hazardous situation which, if not avoided, could result in minor to moderate injury.
- ▶ **NOTICE** is used to address practices not related to personal injury.

Important information



This symbol indicates important information where there is no risk to people or property.

1.2 Safety

Please read before proceeding



The warranty on this water heater is in effect only when the water heater is installed, adjusted, and operated in accordance with these instructions. The manufacturer of this water heater will not be liable for any damages resulting from failure to comply with these instructions. Read these instructions thoroughly before proceeding.



WARNING: IMPROPER OR DANGEROUS OPERATION

- ▶ Installation and service must be performed by a qualified installer or service agency.
- ▶ Improper installation, adjustment, alteration, service or maintenance can cause injury, death, or property damage.



WARNING: INDOOR INSTALLATION ONLY

- ▶ **DO NOT INSTALL OUTDOORS.** This water heater is certified for indoor installation only. Failure to follow these instructions could result in FIRE, PROPERTY DAMAGE, and/or PERSONAL INJURY OR DEATH.



DANGER: HAZARDOUS VOLTAGE

- ▶ Check the data plate on the water heater before installation to make certain the voltage shown is the same as the electric supply to the water heater.
- ▶ This water heater must be connected only to a properly grounded electrical supply. Do not fail to properly ground this water heater (see "Electrical Connections", on page 8).
- ▶ Turn off the electrical supply before servicing this water heater.



WARNING: IMPROPER OR DANGEROUS OPERATION

- ▶ Do not use this water heater if it has damaged wiring, is not working properly, or has been damaged or dropped.



WARNING: FIRE, EXPLOSION

- ▶ This appliance shall not be installed in any location where flammable liquids are stored or vapors are likely to be present. Flammable vapors may be drawn to this water heater from other areas of the structure by air currents.

 **WARNING: SCALD HAZARD**

- ▶ Scald injury is heightened by increased water temperatures. Hot water can produce 3rd degree burns in 6 seconds at 140°F and in 30 seconds at 130°F.
- ▶ If the Water Heater thermostat is set too high there is Serious Potential for SCALDING.
- ▶ Children, the disabled and the elderly are at highest risk of being scalded.

Temperature	Time to Produce Serious Burn
120 °F (48 °C)	More than 5 minutes
125 °F (51 °C)	1.5 to 2 minutes
130 °F (54 °C)	Approx. 30 seconds
135 °F (57 °C)	Approx. 10 seconds
140 °F (60 °C)	Less than 5 seconds
145 °F (62 °C)	Less than 3 seconds
150 °F (65 °C)	Approx. 1.5 seconds
155 °F (68 °C)	Approx. 1 second

Table 1

DANGER

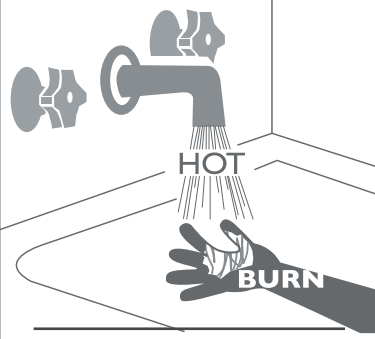

Water temperature over 120°F can cause severe burns instantly or death from scalds.

Children, disabled and elderly are at highest risk of being scalded.

See instruction manual before setting temperature at water heater.

Feel water before bathing or showering.

Temperature limiting valves are available, see manual.

 When this water heater is supplying general purpose hot water requirements for use by individuals, a thermostatically controlled mixing valve for reducing point-of-use water temperature is recommended to reduce the risk of scald injury. Contact a licensed plumber or the local plumbing authority for further information.

 **WARNING: DANGEROUS OPERATION, PERSONAL INJURY**

Water piping, fittings, and valves must be properly installed for the correct and safe operation of this water heater. Please note the following:

- ▶ DO NOT install this water heater with iron piping. The system should be installed only with new piping that is suitable for potable (drink-able) water such as copper, CPVC or polybutylene. DO NOT use PVC water piping.
- ▶ DO NOT use any pumps, valves, or fittings that are not compatible with potable water.
- ▶ DO NOT use valves that may cause excessive restrictions to water flow. Use full flow ball or gate valves only.
- ▶ DO NOT use 50/50 tin-lead solder (or any lead based solder) in potable water lines. ONLY use 95/5 Tin/antimony or other equivalent materials.
- ▶ DO NOT tamper with thermostat heater elements, electrical connections, or temperature and pressure relief valve. Tampering with any of these components is DANGEROUS and can result in property damage, severe injury or death. Tampering voids all warranties. Only qualified technicians should service the above components.
- ▶ DO NOT use with piping that has been treated with chromates, boiler seal, or other chemicals.
- ▶ DO NOT add any chemicals to the system piping which will contaminate the potable water supply.
- ▶ DO NOT install check valves on the cold water supply line to the water heater.

 **WARNING:**

- ▶ This product can expose you to chemicals including Lead and Lead components, which are known to the State of California to cause cancer and birth defects or other reproductive harm. For more information go to www.P65Warnings.ca.gov.

FOR INSTALLATIONS IN THE STATE OF CALIFORNIA

California Law requires that residential water heaters must be braced, anchored or strapped to resist falling or horizontal displacement due to earthquake motions. For residential water heaters up to 52 gallon capacity, a brochure with generic earthquake bracing Instructions can be obtained from: 2808 Metropolitan Place Pomona, CA. 91767 USA 1-888-883-0788 or ask a water heater dealer.

FOR INSTALLATIONS IN THE STATE OF MASSACHUSETTS

Massachusetts Code requires this water heater to be installed in accordance with Massachusetts 248-CMR 2.00: State Plumbing Code and 248-CMR 5.00.

 Applicable local codes govern installation.

SAVE THESE INSTRUCTIONS

INSTALLER:

- ▶ Affix these instructions to or adjacent to the water heater.
- ▶ Before leaving the premises, review this operating and service manual to be sure that the water heater has been installed correctly. Start and operate the unit for one complete cycle and make sure the water temperature is acceptable to the consumer at the outlet fixtures.

Please complete the following information at the time of installation, retain and present along with the warranty in the event that a claim is necessary.

Model Number: _____ Type: _____

Serial Number: _____

THIS WATER HEATER HAS BEEN INSTALLED IN ACCORDANCE WITH THESE INSTALLATION INSTRUCTIONS AND LOCAL CODE REQUIREMENTS ON

Date: _____

OWNER:

- ▶ Retain these instructions and warranty for future reference. Retain the original receipt as proof of purchase.

2 General Information



WARNING: PERSONAL INJURY, PROPERTY DAMAGE

- ▶ The manufacturer's warranty does not cover any damage or defect caused by installation or attachment or use of any special attachment such as energy saving devices (other than those authorized by the manufacturer) into, onto or in conjunction with the water heater. The use of such unauthorized devices may shorten the life of the water heater and may endanger life and property. The manufacturer disclaims any responsibility for such loss or injury resulting from the use of such unauthorized devices.

INSPECT SHIPMENT - for possible damage. The manufacturer's responsibility ceases upon delivery of goods to the shipper in good condition. Any claims for damage, shortage in shipments, or no delivery must be filed immediately against carrier by consignee.

NOTICE: PRODUCT DAMAGE

- ▶ Do not turn on electrical current to water heater elements until the tank has been completely filled with water. Open several hot water faucets to allow air to escape from the system while tank is filling. The heating elements will be damaged if not completely immersed in water if energized for even a short time.



DANGER: HAZARDOUS VOLTAGE

- ▶ Before removing any access panels or servicing the water heater make sure the electrical supply to the water heater is turned "OFF". Failure to do this may result in DEATH, SERIOUS BODILY INJURY OR PROPERTY DAMAGE.



Local codes and requirements in your area may require that the water heater be installed in such way that the bottom thermostat is elevated at least 18 inches from the floor.

The temperature of the water in the heater is regulated by the adjustable surface mounted thermostat(s) located behind the jacked access panel(s). Dual element water heaters have two thermostats. To comply with safety regulations the thermostat(s) are set at 125°F before the water heater is shipped from the factory.

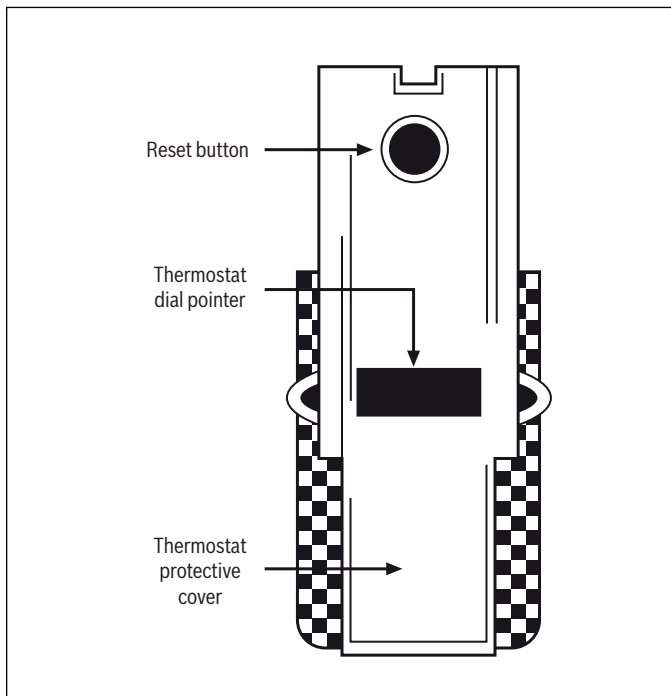

Figure 1

The illustration above shows the temperature adjustment dial used for setting the water temperature.

Refer to the Operating Instructions in this manual for detailed instructions on how to adjust the thermostat(s).

3 Insulation

3.1 Insulation Blanket

Some governing bodies may require the use of external insulation blankets when water heaters are installed in newly constructed homes and/or additions. If an insulation blanket is used on this water heater CAUTION must be exercised so as to not restrict its proper function and operation. Please note the following:

- ▶ Do not cover the temperature and pressure relief valve or any labels or instruction materials applied to the water heater. These labels must remain visible for reference by the user.
- ▶ Do not remove any labels as they are a permanent part of the water heater as required by certification agencies and/or the Federal Government.
- ▶ Do not cover any access panels leading to element compartments.
- ▶ Do not cover or obstruct ventilation openings in electrical compartment or place insulation in contact with electrical compartment panel door

3.2 Pipe Insulation

Two sections of polyethylene foam pipe insulation are provided. Install on the water pipes to protect from freezing and to minimize heat loss.

4 Specifications

Model Number	Nominal Gallons	Rated Volume (DOE)	First Hour Rating	Maximum Watts	GPH REC @ 90° Rise	Uniform Energy Factor	R Factor
ES30M	30	27.4	43.5	4,500	21	0.92	24
ES40M	40	36.33	51.3	4,500	21	0.93	24
ES50M	50	45.37	63.6	4,500	21	0.92	24
ES40T	40	36.12	54.2	4,500	21	0.92	24
ES50T	50	46.0	60.0	4,500	21	0.92	24
ES40LB	40	38.0	47.0	4,500	21	0.91	24
ES50LB	46	42.0	58.0	4,500	21	0.93	24

Table 2

5 Dimensions

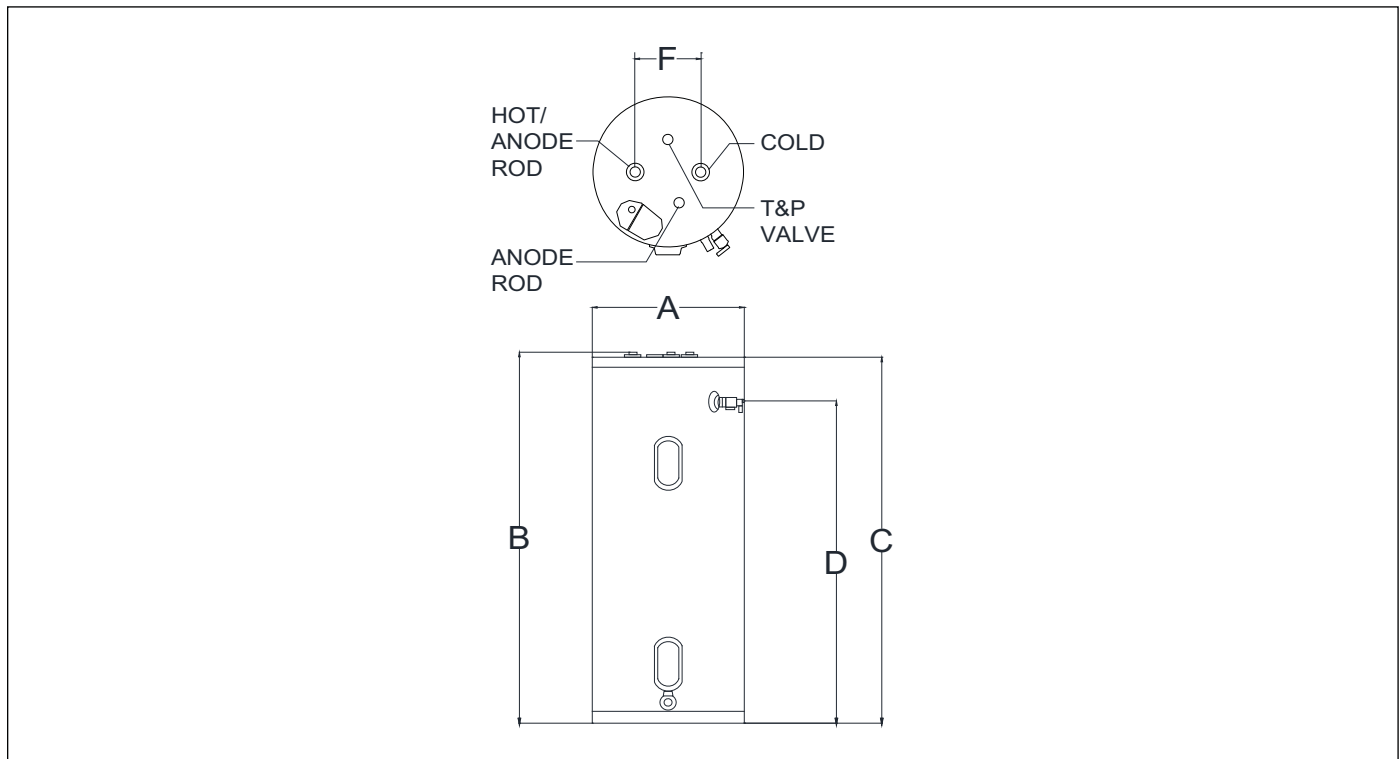

Figure 2

Model Number	Dimensions in inches (floor to)					Approx Ship Weight (Lbs)	Recommended Drain Pan Diameter (Inches)
	Jacket Diameter	Water Conn	Top of Heater	Side T&P	Water Spread		
	A	B	C	D	F		
ES30M	18 1/4	50	48	41 3/4	8	94.5	20
ES40M	20 1/4	51 1/7	49 1/7	42 1/2	8	112.5	22
ES50M	22 1/4	50 3/4	48 3/4	41 3/4	8	129	24
ES40T	18 1/4	63 3/5	61 3/5	55 1/3	8	116	20
ES50T	20 1/4	61 3/4	59 3/4	53 5/7	8	150	22
ES40LB	24 1/4	36 1/2	34 1/2	27	8	135	26
ES50LB	26 1/4	36 1/2	34 1/2	26 1/3	8	146	28

Table 3

6 Water Chemistry Requirements

NOTICE:

- ▶ Chemical imbalance of the water supply may affect efficiency and cause severe damage to the appliance and associated equipment. Water quality must be professionally analyzed to determine whether it is necessary to treat the water. Various solutions are available to adjust water quality. Adverse water quality will affect the reliability of the system. In addition, operating temperatures above 135°F will accelerate the build-up of lime scale and possibly shorten appliance service life. Failure of an appliance due to lime scale build-up, low pH, or other chemical imbalance IS NOT covered by the warranty.

The water must be potable, free of corrosive chemicals, sand, dirt, and other contaminants. It is up to the installer to ensure the water does not contain corrosive chemicals or elements that can damage the heat exchanger. Potable water is defined as drinkable water supplied from utility or well water in compliance with EPA secondary maximum contaminant levels (40 CFR Part 143.3). If the water contains contaminants higher than outlined by the EPA, water treatment is required.

If you suspect that your water is contaminated in any way, discontinue use of the appliance and contact an authorized technician or licensed professional.

Water pH must be between 6.5 and 8.5

- ▶ pH levels below 6.5 can cause an increase in the rate of corrosion. pH of 8.5 or higher can potentially cause lime scale build-up.
- ▶ Maintain water pH between 6.5 and 8.5. Check with litmus paper or have it chemically analyzed by a local water treatment company.
- ▶ If the pH is not between 6.5 and 8.5, consult a local water treatment company for solutions.

Water Hardness

- ▶ Water hardness levels above the upper limit of 7 grains/gallon (120 mg/L) can lead to lime scale build-up throughout the system. Water hardness below the lower limit of 5 grains/gallon (85 mg/L) may be over-softened.
- ▶ Consult local water treatment companies if the water hardness is outside the required level of between 5 and 7 grains/gallon.

Chloride concentration must be less than 100 ppm (mg/L)

- ▶ Do not fill appliance or operate with water containing chlorides in excess of 100 ppm (mg/L).
- ▶ Using chlorinated fresh water is acceptable if the level of chloride concentration is less than 5ppg (mg/L).
- ▶ Do not connect the appliance to directly heat swimming pool or spa water.

Total Dissolved Solids (TDS) must be less than 500 ppm (mg/L)

- ▶ Total dissolved solids are minerals, salts, metals, and charged particles that are dissolved in water.
- ▶ The greater the amounts of TDS present, the higher the corrosion potential due to increased conductivity in the water.
- ▶ If using softened water to fill the appliance, it is still possible to have high TDS. This water can be corrosive. Consult local water treatment companies for other treatment solutions to reduce this affect.



Follow the required maintenance procedures in this manual to promote appliance service life.

NOTICE: PRODUCT DAMAGE

- ▶ Failure of electric elements due to lime scale build-up on the heating surface, low pH, or other imbalance IS NOT covered by the warranty.

7 Installation



WARNING: PERSONAL INJURY, PROPERTY DAMAGE

- ▶ This water heater should be installed in accordance with all national, state and local codes and ordinances. If additional information is desired, the latest edition of the National Electric Code "NFPA 70" are recommended.

The above information is available from:

National Fire Protection Agency
1 Batterymarch Park
Quincy, MA 02269

American National Standards Institute
1430 Broadway
New York, NY 10018

Check with the local authorities having jurisdiction over your installation.



Before proceeding with the installation, close the main water supply valve, open a water faucet to relieve the water pressure, and then close the faucet.



This electric water heater is not intended for space heating applications.

7.1 Location



WARNING: FIRE, EXPLOSION

- ▶ Areas where flammable liquids (gasoline, solvents, liquid propane, butane, etc.), or other substances which emit flammable vapors are stored may not be suitable for water heater installation. Natural air movements can carry flammable vapors varied distances from where they are stored or used. The water heater thermostat contacts can arc and ignite these vapors causing property damage, serious burns or death. Never store or use flammable substances in the same room or area containing an electric water heater. Gasoline or other flammable substances must never be used in the same room or area containing a water heater or other spark-producing device.

This residential water heater should be installed in a clean, dry location close to where a good electrical connection can be made and as close to the major usage of hot water as possible. The unit can be installed on a combustible floor with 0 inches minimum clearance to combustible walls. The heater should be located so that all electrical controls, heating elements, drain valve and water connections are accessible. Adequate clearance must be provided for the access panel.

NOTICE: PROPERTY DAMAGE

- ▶ This water heater must be located in an area where leakage of the tank or connections will not result in damage to the area adjacent to the water heater or to lower floors of the structure. When such locations cannot be avoided, a suitable drain pan must be installed under the water heater. Such pans must be at least 2 inches deep having a minimum length and width of at least 2 inches greater than the diameter of the water heater and should be piped to an adequate drain.

7.2 Condensation

Condensation can form on the tank when it is first filled with water. Condensation might also occur with a heavy water draw and very cold inlet water temperature. This condition is not unusual and will evaporate after the water becomes heated. If, however, the condensation continues, examine the piping and fittings for possible leaks.

7.3 Water Lines and Connections

- ▶ The cold water line connects to the inlet nipple on top of the water heater.
- ▶ The hot water line connects to the outlet nipple on top of the water heater.
- ▶ By providing unions on the water connections and a shut off valve in the cold water line, the water heater may be disconnected for servicing when necessary.



It is highly recommended to use dielectric unions. Dielectric unions can help prevent corrosion caused by small electric currents common in copper water pipes and can help extend the life of the water heater.

- ▶ Two temperatures of hot water can be achieved by a mixing valve.
- ▶ All hook-ups must comply with all local codes. Install a vacuum relief anti-siphon device on the cold water inlet line.

NOTICE: PRODUCT DAMAGE, PROPERTY DAMAGE

- ▶ Do not install a check valve or other back flow device that creates a closed system unless required by code. A closed system may result in frequent discharge due to thermal expansion from the pressure relief valve.

7.4 Piping Installation

Water supply pressure should not exceed 80% of the working pressure of the water heater. The working pressure is stated on the water heaters' data plate. If this occurs, a pressure limiting valve with a by-pass may need to be installed in the cold water inlet line. This should be placed on the supply to the entire building in order to maintain equal hot and cold water pressures.



Heat cannot be applied to the water fittings on the water heater as they may contain nonmetallic parts. If solder connections are used, solder the pipe to the adapter before attaching the adapter to the hot and cold water fittings.



Always ensure that all fittings are free from leaks.

7.5 Closed System/Thermal Expansion

Periodic discharge of the temperature and pressure relief valve may be due to thermal expansion in a closed water supply system. The water utility supply meter may contain a check valve, backflow preventer or water pressure reducing valve. This will create a closed water system. During the heating cycle of the water heater, the water expands causing increased pressure inside the water heater. The temperature and pressure relief valve may discharge hot water under these conditions which results in water escaping from the valve and a build-up of lime on the relief valve seat. To prevent this from happening, it is recommended to:

1. Install a diaphragm-type expansion tank that is suitable for potable water on the cold water supply line. The expansion tank must have a minimum capacity of 1.5 US gallons for every 50 gallons of stored water.

NOTICE: PRODUCT DAMAGE, PROPERTY DAMAGE

- ▶ Do not attempt to operate this water heater with the cold water shut off valve closed. This can result in serious damage to the water heater tank.

7.6 Relief Valves



WARNING:

- ▶ The pressure rating of the relief valve must not exceed 150 PSI, and not exceed the maximum working pressure of the water heater as marked on the rating plate.



WARNING: PERSONAL INJURY, PROPERTY DAMAGE

- ▶ Failure to install a listed, adequately sized temperature & pressure relief valve will release the manufacturer from any claim which might result from excessive temperatures and pressures.

To reduce the risk of excessive pressures and temperatures in this water heater, install temperature and pressure protective equipment required by local codes and no less than a combination temperature and pressure relief valve certified by a nationally recognized testing laboratory that maintains periodic inspection of production of listed equipment or materials, as meets the requirements for Relief Valves and Automatic Gas Shut-off Devices for Hot Water Supply Systems, ANSI Z21.22. This valve must be marked with a maximum set pressure not to exceed the marked maximum working pressure of the water heater. Install the valve into opening provided and marked for this purpose on the water heater, and orient it or provide tubing so that discharge from the valve is 6 inches above, or at any distance below, the structural floor, and does not contact any live electrical part. The discharge opening must not be blocked or reduced in size under any circumstances.

Your local jurisdictional authority, while mandating the use of a temperature-pressure relief valve complying with ANSI Z21.22•CSA 4.4 and ASME, may require a valve model different from the one furnished with the water heater.

Compliance with such local requirements must be satisfied by the installer or end user of the water heater with a locally prescribed temperature-pressure relief valve installed in the designated opening on the water heater in place of the factory furnished valve.

For safe operation of the water heater, the relief valve must not be removed from it designated opening or plugged.

As an option the T&P relief valve could be placed at it's designated opening on the top of the water heater (Refer to Part reference illustration).

If other components within the system have a lower working pressure, the relief pressure rating should be selected accordingly. The BTU rating of the valve must not be less than the input rating of the water heater.

Only a new temperature and pressure relief valve should be used with this water heater. Do not use an old or existing valve as it may not be adequate for the working pressure of the new water heater.

Piping used should be of a type approved for hot water distribution. The discharge line must be no smaller than the outlet of the valve and must pitch downward from the valve to allow complete drainage (by gravity) of the relief valve and discharge line. The end of the discharge line should not be threaded or concealed and should be protected from freezing. No valve of any type, restriction or reducer coupling should be installed in the discharge line.

Excessive length, over 30 feet, or use of more than four elbows can cause restriction and reduce the discharge capacity of the valve.

Temperature & Pressure Relief Valve

The temperature & pressure relief valve:

- ▶ Must not be in contact with any electrical part
- ▶ Must be connected to a proper discharge line which terminates at an adequate drain.
- ▶ Must not exceed the working pressure shown on the data plate of the water heater.
- ▶ Must be of materials listed for hot water distribution.

Manually operate the temperature and pressure relief valve at least once a year to make sure it is working properly. To prevent water damage the valve must be properly connected to a discharge line which terminates at an adequate drain.

Standing clear of the outlet (discharged water may be hot), slowly lift and release the lever handle on the temperature and pressure relief valve to allow the valve to operate freely and return to its closed position. If the valve fails to completely reset and continues to release water, immediately shut off the electrical power and the cold water inlet valve and call a qualified service technician.

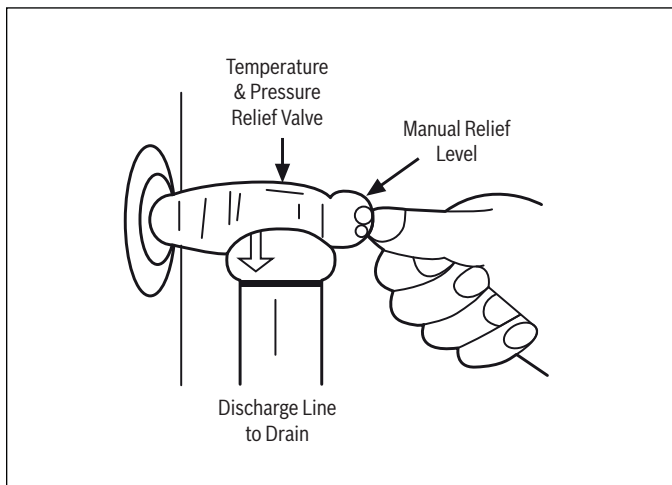

Figure 3

Discharge Line



WARNING: SCALD HAZARD, PROPERTY DAMAGE

- ▶ Discharging water may be hot and can cause scald injuries and property damage. Discharge lines must be properly installed and piped to an adequate drain.

The discharge line:

- ▶ Must not be smaller than the pipe size of the relief valve.
- ▶ Must not be capped, blocked, plugged or contain any valve between the relief valve and the end of the discharge line.
- ▶ Must terminate 6 inches above a floor drain or external to the building.
- ▶ Must be capable of withstanding 250°F (121°C) without distortion.
- ▶ Must be installed to allow complete drainage of both the temperature and pressure relief valve and discharge line.

Figure 4

7.7 Recirculating Lines

In some installations a return circulation line may be installed. The recirculation line can be connected to the drain valve or cold water inlet connection using a tee.

7.8 Turning on Water to Heater

After piping and hook-ups are completed, open all hot water outlets. Open cold water inlet valve to fill tank. As each hot water outlet delivers water free from air, it can be shut off. Check the system for leaks.



WARNING: SHOCK HAZARD

- ▶ Be careful not to allow escaping water to contact electrical wires.

7.9 Electrical Diagram

This guide recommends minimum branch circuit sizing and wire size based on National Electric Codes. Refer to wiring diagram in this manual for field wiring connections.

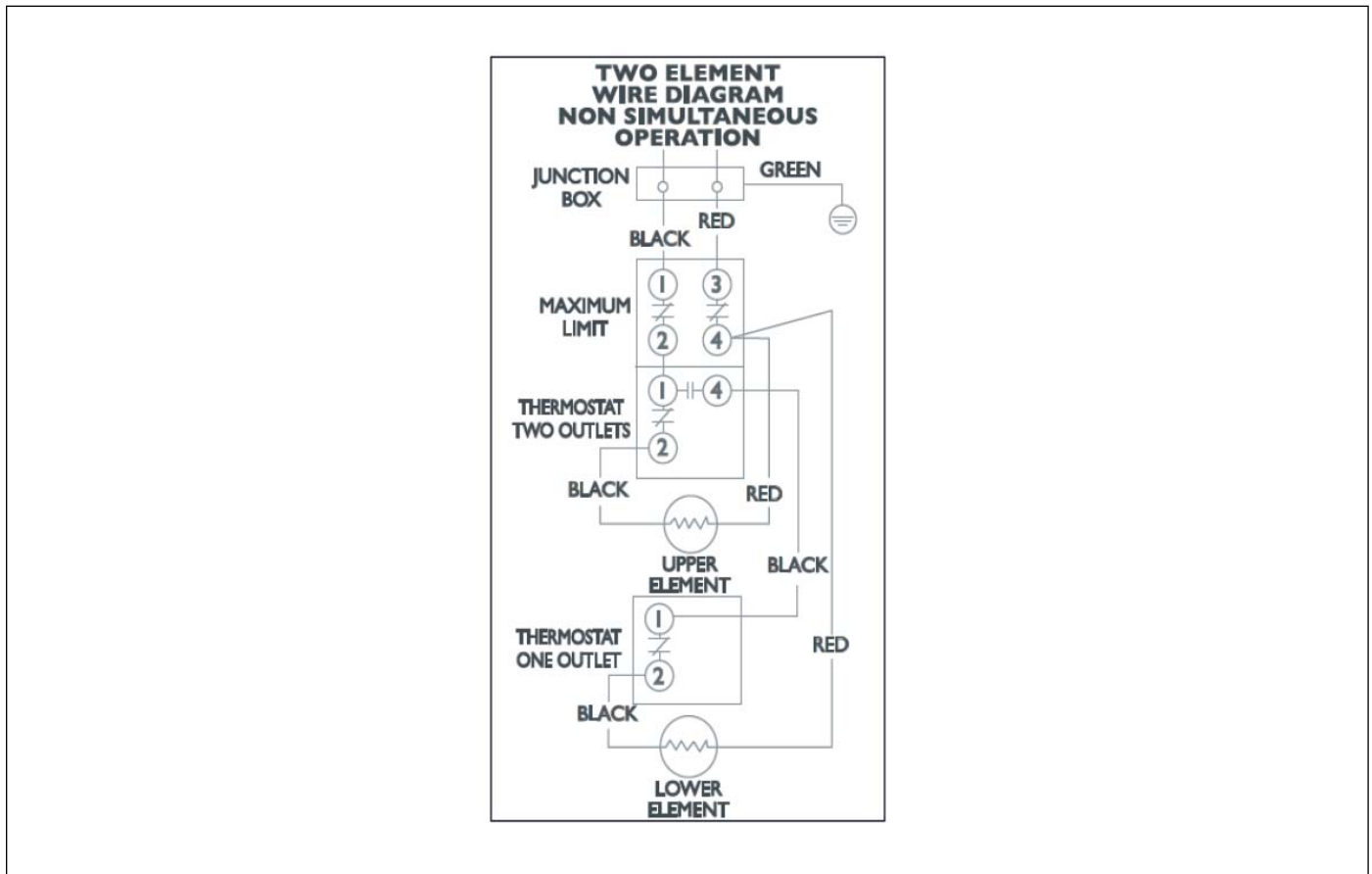



Figure 5

Total Water Heater Wattage	Phases	Recommended Over Current Protection (Fuse or Circuit Breaker) Amperage Rating	Copper Wire Size AWG Based on N.E.C. Table 310-16 (75°C)
		240V	240V
4,500	1	25	10

Table 4



WARNING: HAZARDOUS VOLTAGE

- ▶ If wiring from your fuse box or circuit breaker box was aluminium for your old water heater, replace it with copper wire. If you wish to reuse the existing aluminium wire, have the connection at the water heater made by a qualified electrician.

7.10 Electrical Connections



WARNING: FIRE, SHOCK HAZARD, PROPERTY DAMAGE

- ▶ Do not use this water heater with any electrical supply voltage other than the one listed on the data plate. This water heater is equipped for use with one voltage rating only. Check the data plate on the front of the water heater for the correct voltage rating. Failure to use the correct voltage can cause problems which can result in death, serious bodily injury or property damage. If you have any questions or doubts consult your electrical utility company before installing this water heater.



WARNING: HAZARDOUS VOLTAGE

- ▶ If you lack the necessary skills required to properly install the electrical wiring to this water heater, DO NOT PROCEED, but have a qualified electrician perform the installation.
- ▶ Before installing electrical wiring, make sure the electrical supply to the water heater is turned "OFF".



WARNING: IMPROPER OPERATION

- ▶ This Electric Residential Water Heater is designed for operation as specified on the rating plate. All electrical connections to elements and thermostats have been made at the factory. DO NOT ALTER any of the internal wiring.



WARNING: SHOCK HAZARD

- ▶ The presence of water in the piping and water heater does not provide sufficient conduction for a ground. Nonmetallic piping, dielectric unions, flexible connectors, etc., can cause the water heater to be electrically isolated.



NOTICE: PRODUCT DAMAGE

- ▶ Before closing the switch to allow the electric current to flow to the water heater, make certain that the water heater is completely full of water and that the cold water inlet valve is open. If the heating elements are not completely immersed in water at all times, they will be damaged if energized for even a short time. When the switch is closed the operation of the water heater is automatic.



Wiring connections may loosen in shipment. Check all connections for tightness.

When making the electrical connections, always make sure:

- ▶ The electrical supply has the proper overload fuse or breaker protection.
 - ▶ Wire sizes and connections comply with all applicable codes.
 - ▶ Wiring is enclosed in approved conduit (if required by local codes).
 - ▶ The water heater and electrical supply are properly grounded.
1. Provide a separate fused disconnect switch for each water heater.
 2. Open cover door of the wiring connection box.
 3. Bring the power leads from an adequately fused disconnect switch (not furnished with the water heater due to varying state and local codes) and use wire nuts to connect the power supply wiring to the wires inside the water heater connection box. Where long runs occur, local ordinances or your utility company may necessitate, an increase in size.
 4. This water heater must be properly grounded. A ground lug is provided within the electrical control box for connection of the properly sized ground.
 5. Close the cover door of the wiring connection box.

7.11 Thermostats and Controls

All Electric Residential Water Heaters feature automatic controls to regulate heating elements. Surface mounted thermostats are used on this water heater. The thermostats are pre-set to provide a water temperature of 125°F to reduce the risk of scald injury.

Care must be taken when using hot water to avoid scalding injury. Certain appliances require high temperature hot water (such as dishwashers and automatic clothes washers). By setting the thermostat on this water heater to obtain increased temperature water required by these appliances, you may create the potential for scald injury. To protect against injury, you should install an ASME approved mixing valve in the water system. This valve will reduce point of discharge temperature by mixing cold and hot water in branch supply lines. Such valves are available from a local plumbing supplier. Please consult with a plumbing professional.



WARNING: PERSONAL INJURY, PROPERTY DAMAGE

- ▶ Make sure the thermostat is flush against the tank, the terminal cover is in place, and the insulation is replaced. Failure to do so can result in DEATH, SERIOUS BODILY INJURY, AND/OR PROPERTY DAMAGE.



WARNING: SCALD HAZARD

- ▶ Adjusting the thermostat past the 125°F bar on the temperature dial will increase the risk of scald injury.



WARNING: SCALD HAZARD

- ▶ Never allow small children to use a hot water tap, or to draw their own bath water. Never leave a child or handicapped person unattended in a bathtub or shower.

Increasing the thermostat setting above the pre-set temperature may consume excessive energy and also might cause the high-limit to shut off power to the water heater under certain operating conditions.

Each water heater has built in Energy Cut Off device(s). If for any reason the water temperature becomes excessively high, the high limit switch breaks the circuit to the heating elements. Once the switch opens, it must be manually reset and the cause of the over temperature condition must be corrected. To reset the high limit, follow the written instructions shown on page 13.

7.12 Installation Checklist

Water Heater Location

- ▶ Close to area of heated water demand?
- ▶ Located indoors and protected from freezing temperatures?
- ▶ Area free of flammable vapors?
- ▶ Provisions made to protect area from water damage?
- ▶ Sufficient room to service water heater?

Water Supply

- ▶ Water heater completely filled with water?
- ▶ Water heater and piping air vented?
- ▶ Water connections tight and free of leaks?

Relief Valve

- ▶ Temperature and Pressure Relief Valve properly installed and discharge line run to open drain?
- ▶ Discharge line protected from freezing?

Wiring

- ▶ Power supply voltage agrees with water heater rating plate?
- ▶ Branch circuit wire and fusing or circuit breaker of proper size?
- ▶ Electrical connections tight and unit properly grounded?

See Figure 7 for a finished installation example.

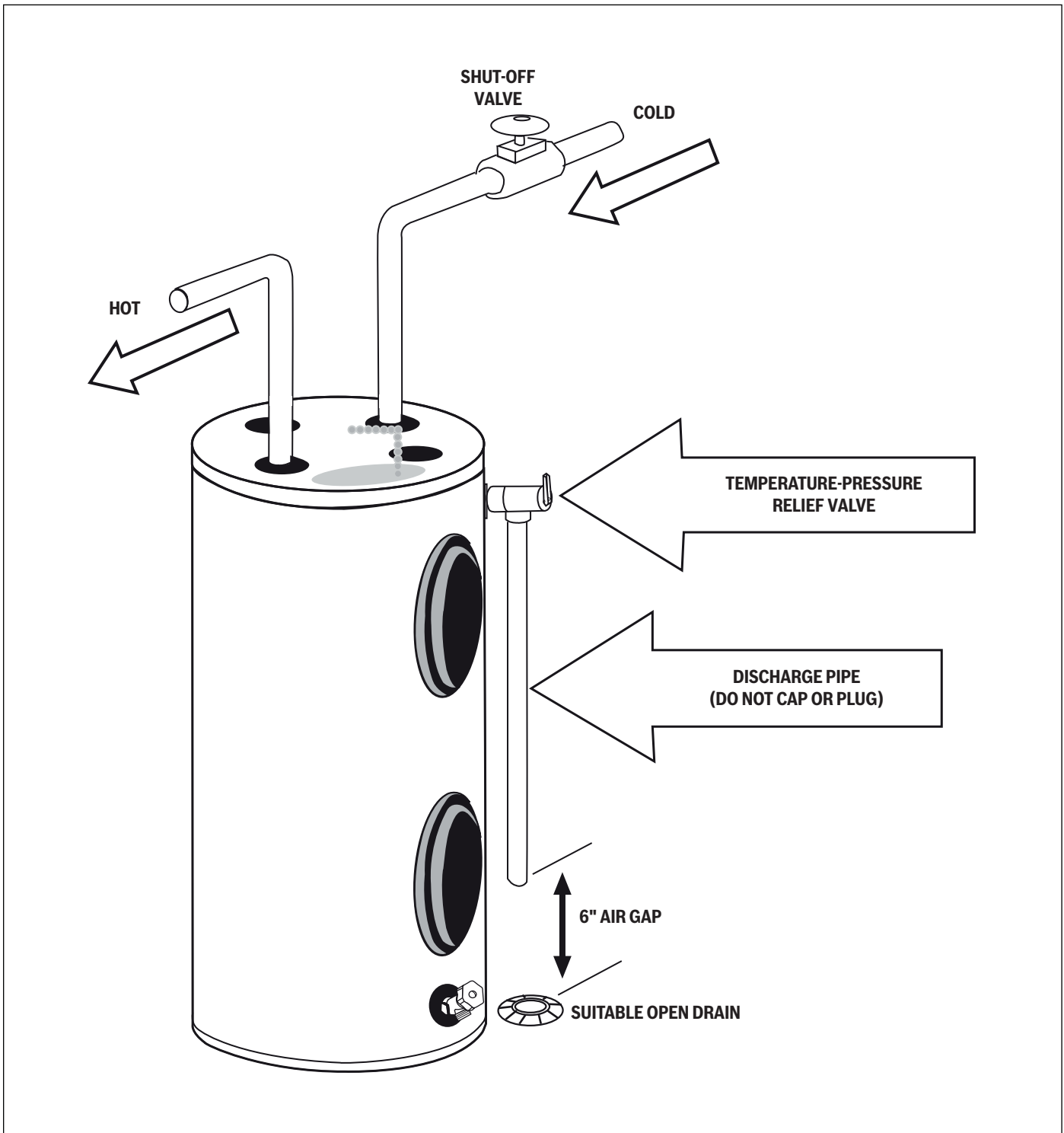



Figure 6 Installation Example

8 Water Temperature Regulation

The thermostat is adjusted to a temperature setting of 125°F or lower when it is shipped from the factory. Water temperature can be regulated by adjusting the thermostat to the preferred settings. The preferred starting point is 125°F. There is a hot water scald potential if the thermostat is set too high.



WARNING: SCALD HAZARD

- ▶ Hot water can produce first degree burns within:
 - Less than 5 seconds at 140°F (60°C),
 - Approx. 30 seconds at 130°F (54°C)
 - 1.5 to 2 minutes at 125°F (51°C)

During low demand periods when hot water is not being used, a lower thermostat setting will reduce energy usage and may satisfy your normal hot water requirements. If hot water use is expected to be more than normal, a higher thermostat setting may be required to meet the increased demand.

When leaving the premises for extended periods, turn the thermostats to their lowest settings. This will maintain the water heater at low temperatures with minimum energy losses and prevent the tank from freezing during cold weather.

Water Temperature Setting



WARNING: SCALD HAZARD

- ▶ Households with small children, elderly, impaired or disable members and anyone with temperature sensitive skin may require lower temperature settings to reduce the risk of scald injury.

1. Turn off the power to the water heater.
2. Remove the jacket access panel(s) and insulation exposing the thermostat(s).
3. Using a small flat blade screwdriver set the thermostat(s) dial pointer(s) to the desired temperature.

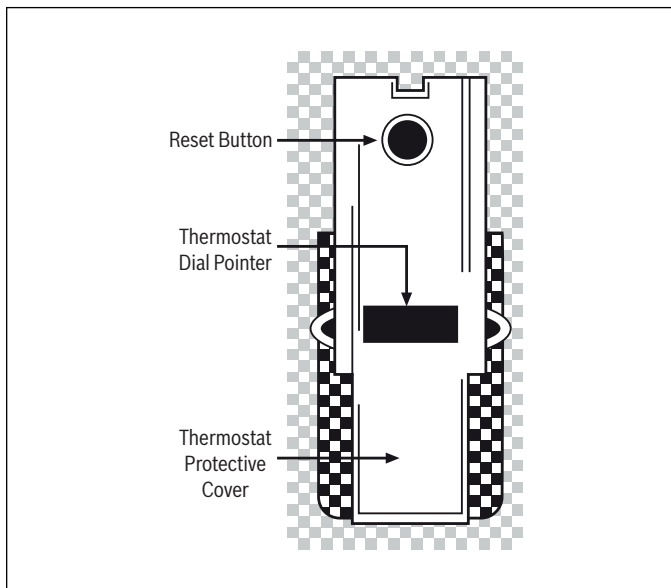



Figure 7 Type 59T Thermostat and Protective Cover

4. Replace the insulation and jacket access panel(s). Turn on the power to the water heater.



Water temperature ranges of 120° - 140°F recommended by most dishwasher manufacturers.

9 Safety Controls

The water heater is equipped with combination thermostat and temperature limiting controls (ECO) that are located above the heating element in contact with the tank surface. If for any reason the water temperature becomes excessively high, the temperature limiting control (ECO) breaks the power circuit to the heating element. Once the control opens, it must be reset manually.



WARNING: IMPROPER OPERATION, PERSONAL INJURY

- ▶ The cause of the high temperature conditions must be investigated by a qualified service technician and corrective actions must be taken before placing the water heater into service again.

To reset the high limit

1. Water in the tank must to be cooled down.
2. Turn off the power to the water heater.
3. Remove the jacket access panel(s) and insulation. The thermostat protective cover should not be removed.
4. Press the red RESET button.
5. Replace the insulation and jacket access panel(s) before turning on the power to the water heater.

10 Seasonal Operation

Vacation/Freezing Temperatures

Drain the piping to the water heater (refer to Page 18) and leave the drain valve open if the water heater is left idle for 30 days or longer and/or is subjected to freezing temperatures while shut off.



WARNING: FIRE, EXPLOSION

- ▶ Hydrogen gas can be produced in a hot water system served by this heater that has not been used for a long period of time (generally two weeks or more). Hydrogen gas is extremely flammable. To reduce the risk of injury under these conditions, open a hot water faucet for several minutes before using any electrical appliance connected to the hot water system. If hydrogen is present, there will probably be an unusual sound, such as air escaping through the pipe as water begins to flow. There should be no smoking or open flame near the faucet at the time it is open.

11 Maintenance



WARNING: MODIFICATION, TAMPERING

- ▶ Tampering with the thermostat, heater elements, electrical connections or temperature and pressure relief valve is dangerous and may result in serious injury or death. Tampering voids all warranties. Only properly trained, qualified service personnel should service these components. Do not attempt to modify or change this water heater in anyway.
- ▶ Conversion or rewiring by unauthorized persons will void the warranty, can nullify the underwriter's laboratories (UL) certification of the water heater and could result in property damage or personal injury for which the manufacturer cannot be responsible.



CAUTION: PERSONAL INJURY, PRODUCT DAMAGE

- ▶ Do not use this appliance if any part has been under water. Immediately call a qualified service technician to inspect the appliance and to replace any part of the control system which has been under water.

Proper preventative maintenance is required and will significantly extend the life of the water heater. Annual inspection of the operating controls, heating element and wiring by qualified service personnel is required.

To obtain service on your water heater when adjustment, repair, or routine maintenance is required it is suggested that you first contact your installer, plumbing contractor or previously agreed upon service agency.

11.1 Draining Heater



WARNING: SCALD HAZARD

- ▶ The water drained from the tank may be hot enough to present a SCALD HAZARD and should be directed to a suitable drain to prevent injury or damage.

NOTICE: PRODUCT DAMAGE

- ▶ When draining the water heater, make sure that the power source to the water heater is shut off before draining water, and completely fill with water before reenergizing.

Drain a few quarts of water to flush out accumulated sediment after the first 6 months then annually thereafter.

Foreign material can wash in and unless the water supply is naturally soft (0 to 5 grains hardness), scale or lime deposits will accumulate in the tank. Hard water scale precipitates at an increasingly high rate in proportion to an increase in water temperature.

Failure of the tank or heating elements due to accumulated deposits does not fall within the scope of the warranty.

It is recommended that a few quarts of water be drained from the heater. This will flush sediment deposits from the bottom of the heater and lengthen the heater's service life.

Turn off power to the heater during flushing operation, so the elements will not be damaged.

To flush the tank, attach a hose to the field installed drain valve. Close the cold water supply line shut-off valve. Open the drain valve and hot water faucet(s) to vent heater while draining. Direct the flow of water to a drain or bucket where it will not cause damage.

Flush until water runs clear to complete this operation. Close drain valve and reopen the supply line shut-off valve. Close the hot water faucet(s) once all air has been bled from the system

If periodic draining of this unit is desired, drain valve can be turned slightly clockwise with a wrench to allow easier connection of the hose.

Make sure water heater is completely filled with water before reenergizing.

11.2 Test the TPR Valve

Test the operation of the relief valve after filling and pressurizing the system. Place a bucket under the pipe connected to the temperature-pressure-relief (TPR) valve on the top or side of the tank. (This valve opens if the tank pressure gets too high.)

Lift the lever. Make sure the valve discharges freely.



Figure 8

Test temperature-pressure-relief (TPR) valve at least once annually to ensure the waterway is clear.

If the valve fails to operate correctly, immediately replace with a new properly rated relief valve.

11.3 Heating Elements

The electric elements are mounted inside the tank to transfer heat directly into the water. These electric elements can become laden with lime and mineral deposits that reduce their effectiveness or cause them to overheat and short out.

At least once a year check the Heating Elements and if they are coated with calcium, clean them using white vinegar and a stiff bristle brush.



Figure 9 Heating Element with Mineral Deposits

To replace an element, DISCONNECT POWER to the water heater, drain tank and replace element. 1 1/2 screw-type element wrenches are available from most supply houses. Do not over tighten new element, as this will cause distortion of the new element gasket. Fill tank with water, opening hot water faucet(s) to allow air to escape from the system while tank is filling. The heating elements will burn out if not immersed in water. Check for leaks before closing door panel or turning on power.



WARNING: HAZARDOUS VOLTAGE

- ▶ Removal and replacement of the heating elements involves the disconnection of electrical wiring. These procedures must only be performed by a qualified service technician.

11.4 Anode Rod

The anode rod is a sacrificial metal rod that avoids corrosion and premature failure (leaks) in the tank. It is a consumable item. The anode rod will need to be replaced before it is depleted. The water heater comes with two anode rods; one stand-alone rod and one incorporated into the hot water outlet (See Figure 12). Inspect the anode rods after the first six months of operation when you drain and flush the tank. Replace the anode rods if they are partially depleted or substantially worn out (See Figure 10). Thereafter, inspect the anode rods annually or more frequently if needed. If you use a water softener, your anode rods will deplete faster than normal and as such would need more frequent inspection.

NOTICE: WARRANTY EXCLUSION

- ▶ Damages or malfunction caused by lack of anode rod maintenance is not covered by the warranty.

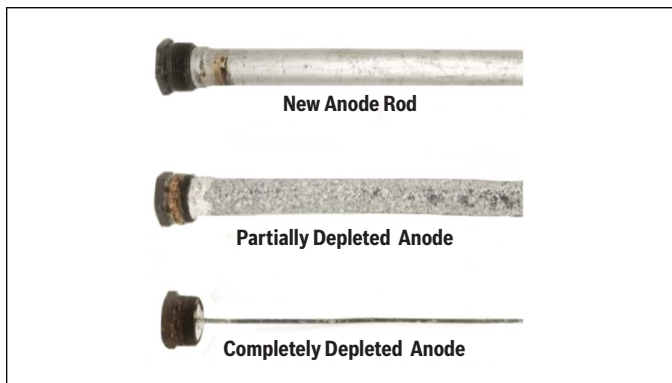

Figure 10



The water heater has two anode rods. See Section 13 Water Heater Components.

To inspect or replace the anode rods:

Stand-alone anode rod

Put a hose to the tank's drain valve and let out a few gallons of water. Remove plastic cap covering the top of the anode rod. Next, fit a 1 1/16-inch socket onto the rod's hex head and unscrew the rod. Replace if the rod is partially depleted (less than 1/2 inch thick) or coated with calcium (See Figure 10). Wrap the new anode rod threads with Teflon tape, put it back in the tank, and tighten securely.

Hot water outlet/anode rod

Put a hose to the tank's drain valve and let out a few gallons of water. Remove the hot water pipe and then remove the combination outlet anode fitting. Replace if the rod is partially depleted (less than 1/2 inch thick) or coated with calcium (See Figure 10). Wrap the new anode rod threads with Teflon tape, put it back in the tank, and tighten securely.

Certain water conditions will cause a reaction between this rod and the water heater, potentially causing smelly water. The parts list includes a special anode for such cases in which the water has a different odor or discoloration due to this reaction. A water conditioning company might have to be contacted to supply filtration equipment if the issue persists.

11.5 Water Heater Sounds

Possible noises due to expansion and contraction of some metal parts during periods of heat-up and cool-down do not represent harmful or dangerous conditions. Sediment build-up in the tank bottom will create varying amounts of noise and should be addressed.

11.6 Sediment Build-Up

Sediment build-up in the tank bottom may result in amounts of noise and may cause premature tank failure. In order to ensure the efficiency and long life of your water heater we recommend to:

- ▶ Drain your water heater every six months.
- ▶ Monthly in hard water areas (hardness 7 grains – 120 mg/L or above)

With this operation, sediment build-up and scale is removed. If not, large scale stones will form and affect your water heater efficiency.

11.7 Leakage Checkpoints

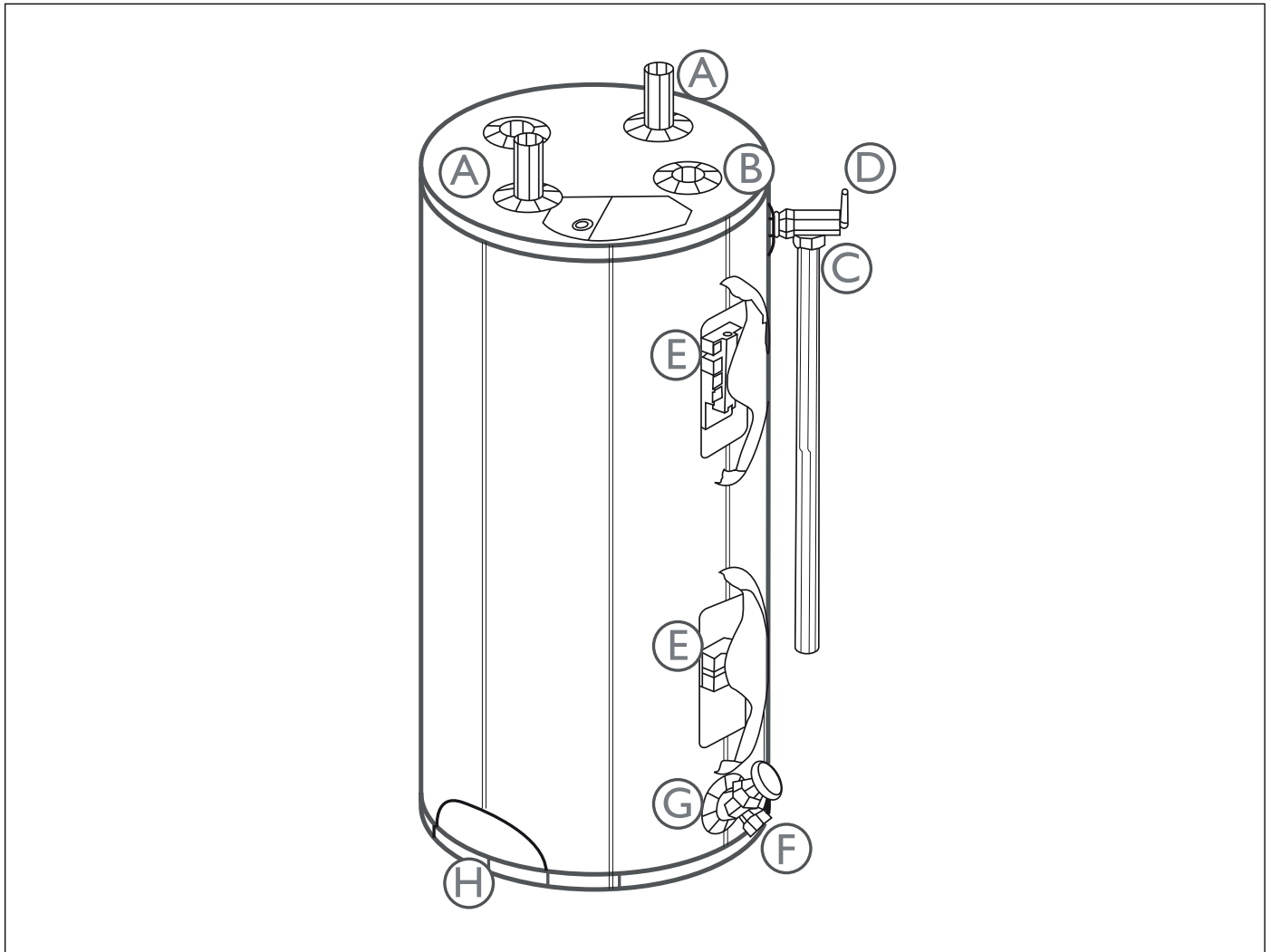

Figure 11

Checkpoint	Description
A	Condensation may be seen on pipes in humid weather or pipe connections may be leaking.*
B	The primary anode rod may be leaking.
C	Small amounts of water from temperature pressure relief valve may be due to thermal expansion or high water pressure in your area.
D	The temperature-pressure relief valve may be leaking at the tank fitting.*
E	The elements may be leaking at the tank fitting. Turn electrical power"OFF", remove access panels and insulation block and pad. If leaking is visible around element, follow proper draining instructions and remove element. Reposition or replace gasket on element. Place element into opening and tighten securely. Then follow "Filling the Water Heater" instructions in the "Installation Instructions" section.
F	Water from drain valve may be due to the valve being opened slightly.
G	The drain valve may be leaking from the tank fitting.*
H	Water in the water heater bottom or on the floor may be from condensation, loose connections or the temperature-pressure relief valve. DO NOT replace the water heater until full inspections of all possible water sources are determined and necessary corrective steps have been taken.*

Table 5

* To check where threaded portion enters tank, insert cotton swab between jacket opening and fitting. If cotton is wet, follow "Draining" instructions in the "Service and Adjustment" section and then remove fitting. Put pipe dope or Teflon tape on the threads and replace. Then follow "Filling the Water Heater" instructions in the "Installation Instructions" section.

12 Troubleshooting

Review the chart on this page first and you may not need to call for service.

Problem	Possible Causes	What To Do
Rumbling noise	Water conditions in your home caused a build up of scale or mineral deposits on the heating elements.	Remove and clean the heating elements.
Relief valve producing popping noise or draining	Pressure build up caused by thermal expansion to a closed system.	This is an unacceptable condition and must be corrected. Turn off power to the water heater until the situation is remedied. Contact the water supplier or plumbing contractor on how to correct this. Do not plug the relief valve outlet.
Rattling noise during periods of water usage	Internal heat trap fittings in operation.	This is normal for heat trap fittings when in operation and does not indicate a need for service.
Not enough or no hot water	Water usage may have exceeded the capacity of the water heater.	Wait for the water heater to recover after a large hot water demand.
	A fuse is blown or a circuit breaker tripped.	Replace fuse or reset circuit breaker.
	Electric supply may be off.	Make sure electric supply to water heater and disconnect switch, if used, are in the ON position.
	The thermostat may be set too low.	See the Temperature regulation of the water heater section of this manual.
	Leaking or open hot water faucets.	Make sure all faucets are closed.
	Electric service to your home may be interrupted.	Contact the local electric utility.
	Improper wiring.	See the Installing the water heater section of this manual. We recommend that all wiring and electrical work be carried out by a licensed contractor.
	Manual reset limit (ECO).	See the Temperature regulation of the water heater section of this manual.
Water is too hot	Cold water inlet temperature may be colder during the winter months.	This is normal. The colder inlet water takes longer to heat.
	Bad or failed element.	Contact a qualified service technician.
Water is too hot	The thermostat is set too high.	See the Temperature regulation of the water heater section of this manual.

Table 6



If further assistance is needed, our technical support team is available Monday to Friday via:
 Email: www.boschheatingcooling.com/contact
 Phone: 1-866-642-3198

13 Water Heater Components

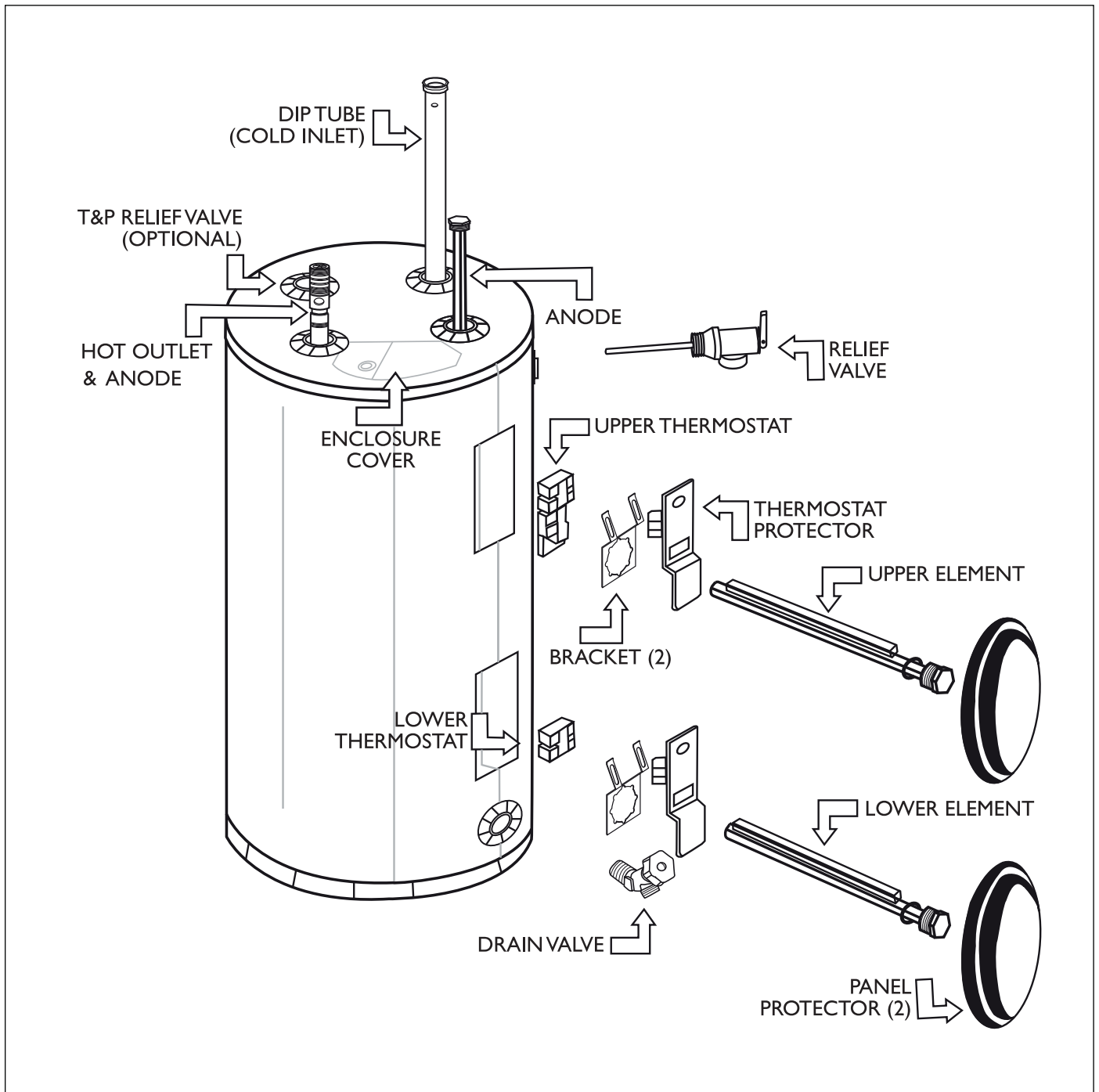

Figure 12

**United States and Canada
Bosch Thermotechnology Corp.
65 Grove St.
Watertown, MA 02472**

**Tel: 866-642-3198
www.bosch-thermotechnology.us**

BTC 724001301 C / 11.2022

**Bosch Thermotechnology Corp. reserves the right
to make changes without notice due to continuing
engineering and technological advances.**